

# Ontario Public Service (OPS) Modern Office Space Version 2.0

---

Enterprise design standards, principles, concepts, strategies and best practices relating to the transformation of office workplaces across the OPS.

December 2023

## INTRODUCTION

---

The workplace as a concept continues to evolve and is influenced by a range of factors including the need to maximize productivity, encourage collaboration, integrate technology and support work-life balance. Modern, efficient, customer-focused government requires new ways of working and these standards can provide support when designing a more flexible office workplace.

The Ontario Public Service (OPS), like other public and private sector organizations, has been updating enterprise workplace strategies to support the shift in how the OPS works. The Ministry of Infrastructure (MOI) and Infrastructure Ontario (IO) are taking an enterprise approach to office space planning that involves the alignment of **People** (Human Resources), **Space** (Real Estate) and **Technology** (Information Technology) across the OPS.

The OPS Modern Office Space (OMOS) is an enterprise design standards document that outlines design principles, concepts, strategies and best practices relating to the transformation of workplaces across the OPS. It serves as a standard for anyone working on office workplace projects (project teams, office space-related design professionals, service providers, consultants, etc.) and provides the foundation, tools and parameters to optimize workplace design. It supports ministries and users of OPS office space with understanding the approach to building modern, flexible office workplaces.

## ABOUT THIS DOCUMENT

---

The OMOS was developed based on industry best practices, interjurisdictional research, and consultation with OPS leaders, subject matter experts and employee networks. It is a living document that will be further developed and regularly reviewed to support the needs of all users of our office workplaces.

The initial version of the OMOS focused on core elements of the office workplace, with an emphasis on work settings that support both focused and collaborative work. As part of its ongoing evolution, the OMOS has been enhanced to incorporate design elements for common shared spaces that support a diverse range of user needs. These new additions include quiet rooms, ceremonial rooms, and wellness/first aid rooms. They also include the colour strategy for office workplaces, which is based on the iconic nature of Ontario. The OMOS will continue to undergo annual updates to reflect further consultation with subject matter experts, partners and stakeholders; refinement of design elements based on experience in OPS office workplaces; and evolving needs for other elements that are critical to modern workplaces, such as:

- » integration of technology within the office workplace; and
- » sustainable and energy-efficient design approaches that enable both tenant wellness and operational cost savings.

Consultation will continue to be an important part of the OMOS development process as additional elements are introduced over time. Engagement with partners and stakeholders is also advised for office transformation projects that include implementation of common shared spaces. This helps to gain user insight into the design and build of these spaces to ensure they meet the needs of the users and the intent of the space while working within the site, building and

budget requirements. Continuous engagement with stakeholders and partners will help ensure continuous improvement in the design and implementation of the space and may be included in future releases of the OMOS.

While the OMOS focuses on design standards for office space, we recognize that additional considerations for how OPS office space is constructed and used are also critical in meeting individual user and business requirements for office workplaces. As the OMOS is further developed and enhanced, operational protocols will be developed and documented to continue supporting the transformation of OPS office workplaces.

The OMOS is informed by [Ontario's Realty Directive](#) to create consistent, efficient and sustainable office accommodation standards for real estate activities across the entire OPS office real estate portfolio. Ontario's Realty Directive sets out the principles, requirements, and responsibilities for the effective and efficient management of government realty, including active consideration of provincial interests with respect to social, environmental and economic purposes for realty.

The standards apply to OPS office space for all ministries and for provincial agencies without realty authority. Provincial agencies with realty authority are not mandated to use the OMOS but may consult them when undertaking any office space projects.

The OMOS should be consulted when planning or implementing any office space project, regardless of the size or scope, including where space is refreshed (limited changes), reworked (moderate changes) or reconstructed (significant

changes). These standards are effective immediately; however, the scope of work for individual projects will depend on the specific needs and feasibility of each project as they are planned and implemented.

The OMOS is divided into four (4) sections: **OPS Modern Office Space Framework, Key Strategies, Key Planning Considerations and Kit of Parts.**

It is an interactive document, where each section includes subsections (e.g. 2.1, 2.1.1) allowing the reader to navigate through the guide quickly and efficiently. To navigate through the sections and subsections of the OMOS please see below:

- » **Section Navigation:** To navigate to a specific section, click on its section title on the Table of Contents or use the bookmarks navigation column to the left.
- » **Sub Section Navigation:** To navigate to a specific subsection, click on its section title on the section title page or use Acrobat's bookmark feature.
- » **Return to the Table of Contents:** To return to the Table of Contents, click on "OPS Modern Space" located at the bottom right of corner of each page or use the bookmarks navigation column to the left.

Please note that some links in the document lead to external websites not managed by the Ontario Government. These websites may have different security and accessibility policies.

# TABLE OF CONTENTS

---

5

OPS MODERN OFFICE  
SPACE FRAMEWORK

9

KEY STRATEGIES

17

KEY PLANNING  
CONSIDERATIONS

27

KIT OF PARTS

88

GLOSSARY

91

ACKNOWLEDGEMENTS

92

CONTACT INFORMATION



777 Bay Street - 5th Floor

## 1.0.0 OPS MODERN OFFICE SPACE FRAMEWORK

---

SECTION 1 INTRODUCES THE CONTEXT FOR THE OPS MODERN OFFICE SPACE STANDARDS AND THE FRAMEWORK ON WHICH IT WAS FOUNDED.

- 1.1.0 Transforming Our Office Workplace
- 1.2.0 Guiding Principles

## 1.1.0 TRANSFORMING OUR OFFICE WORKPLACE

OPS workplaces are embracing a new way of working called Activity-based Working (ABW) and shifting away from the traditional model of one dedicated workspace per person. This new way of working allows more flexibility in how we work in the office and aligns people, space and technology. (Figure 1).

### Key aspects to transform the OPS workplace include:

- » Supporting largely unassigned workspaces with a staff to workspace sharing ratio that meets or exceeds the Ontario Realty Directive;
- » Updating how we design and use existing workplaces to allow for greater collaboration and optimization of the office footprint now and in the future;
- » Supporting the office as a destination – enabling the evolution of Activity-based Working and in-person collaboration;
- » Incorporating technology that allows flexibility in where and how staff work; and
- » Incorporating a focus on digital records management, where feasible.

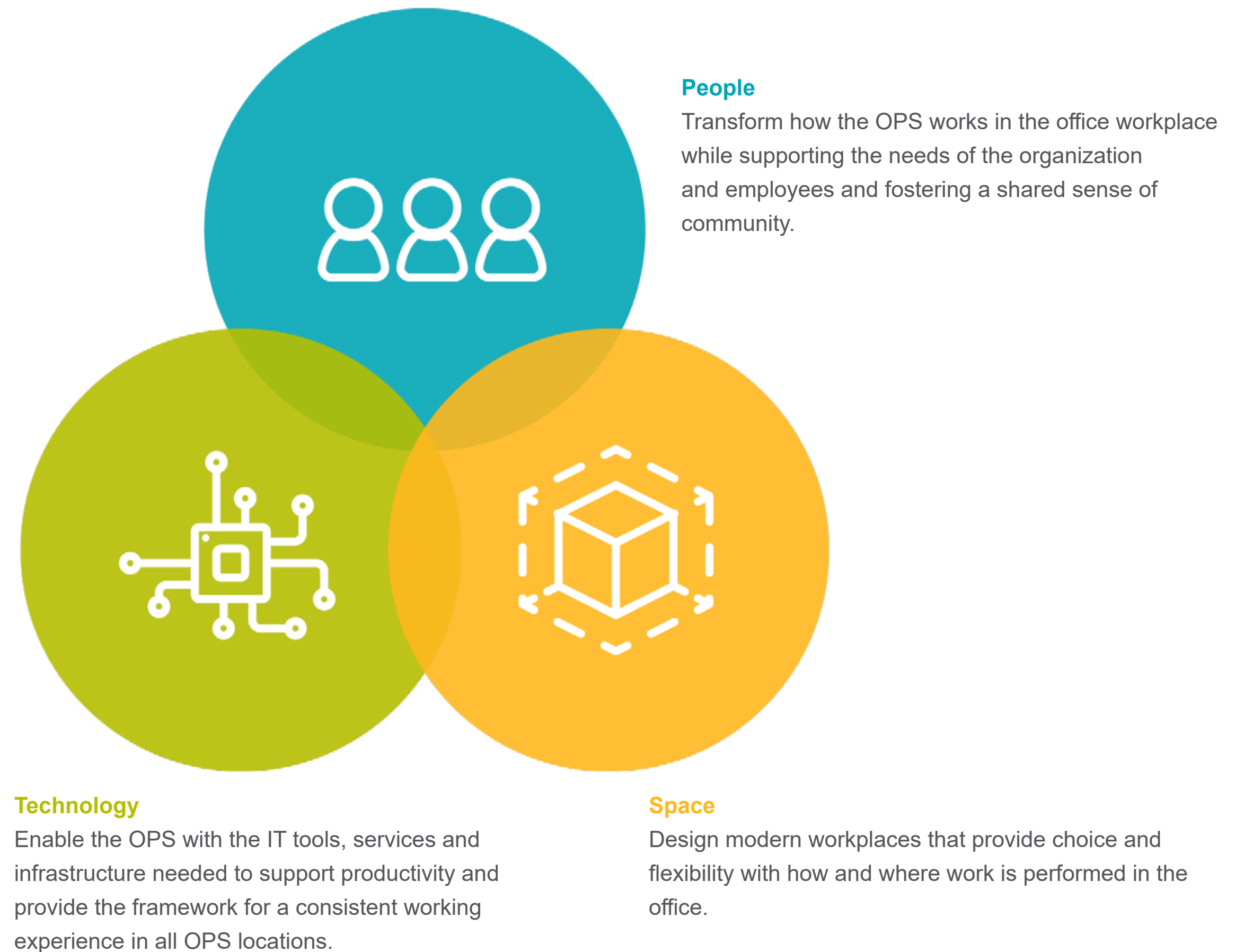

## 1.2.0 GUIDING PRINCIPLES

From March to September 2021, extensive engagement sessions were conducted with various OPS stakeholders that supported the development of these standards. Through these engagements, four (4) Guiding Principles were developed:

1. A future-ready work environment,
2. The office as a destination,
3. Consistent experience; and
4. Frictionless mobility.

The four (4) Guiding Principles contribute to the overall space planning strategy when undertaking projects within our office space and/or broader workplace transformation.



315 Front St. W

### **1.2.1 Guiding Principle 1: A future-ready work environment**

The organizations' and employees' needs have changed over time and will continue to evolve. An office environment that can adapt to meet those future needs will ensure the organization remains competitive and continues to attract and retain talent. A design strategy that embraces flexibility, modularity, and standardization through continuous improvement is the pillar of a future-ready work environment.

### **1.2.3 Guiding Principle 3: Consistent experience**

Standardizing space types, aligned with technology and policies across ministries leads to a consistent and equitable experience for all employees.

- » Promote equity in the office environment.
- » Create an accessible and inclusive workplace.

### **1.2.2 Guiding Principle 2: The office as a destination**

Interacting with colleagues and clients is a primary reason that employees come into the office. A destination office needs to encourage and support human interaction, as well as provide inspiration, while still supporting productivity.

- » Enable employee interaction and integration.
- » Create an inspiring environment and a workplace experience.
- » Create balance by supporting all work styles.

### **1.2.4 Guiding Principle 4: Frictionless mobility**

To create frictionless days, employees must have greater ease of access to people, space and technology. The workplace, technology and policies should support employees as mobility increases. It is essential to create opportunities and reasons for employees to be mobile and remove or limit behaviours that restrict mobility.

- » Provide choice and a variety of work settings within the office workplace.
- » Provide intuitive and seamless virtual and physical experiences.





222 Jarvis St.

## 2.0.0 KEY STRATEGIES

THE KEY STRATEGIES OUTLINED IN THIS SECTION MAKE UP THE BUILDING BLOCKS THAT SUPPORT THE OMOS AND MODERN OFFICE WORKPLACES THAT ARE INCLUSIVE, ACCESSIBLE, ADAPTIVE, INNOVATIVE AND SUSTAINABLE.

This enables workspaces to be flexible and adaptable to support the various types of work required within the office workplace and cost-effectively meet changing organizational needs over time.

### 2.1.0 Planning Strategies

## 2.1.0 PLANNING STRATEGIES

The different planning strategies outlined in this section define and support the overall approach to space planning.

### 2.1.1 Activity-Based Working

We are embracing a new way of working called Activity-based Working and shifting away from the traditional model of one dedicated workspace per person.

This new way of working recognizes that employees perform a variety of activities throughout the day, such as focusing, collaborating, and gathering. The modern and flexible work environment focuses on the employee's experience, offering a range of work settings (i.e. workspaces, alternative workspaces and support spaces within a workplace). Activity-based Working provides increased flexibility and allows employees to be supported and work from various locations while in the office.

In this modern office environment, the furniture and or space will be configured so that the majority of employees are not assigned a designated workspace. Instead, they will have the opportunity to choose their preferred work setting in the workplace (when available), whether a workspace or an alternative workspace (options will vary depending on the location or project).

Meeting rooms, working lounges, open collaboration areas, etc. are examples of alternative work settings where work can take place. These options offer more opportunities for interactions and promote a stronger sense of community.

In the new work environment, most seating will be unassigned, though

accommodations can be made when required, (i.e. as part of individual employment accommodation plans or due to ministry program area-specific requirements).

In the new work environment, employees may expect:

- » Wi-Fi enabled workplace and/or data network connectivity in the office workplace.
- » Increased emphasis on electronic document management and limited centralized filing for business-related items.

A variety of work settings are required to support different types of work, including:

#### Focus

Requires concentration and a distraction-free environment. Some focus activities include telephone conversations, writing, reading and online learning (examples of work settings where these activities can take place in are offices, individual workspaces, and 60-minute rooms).

#### Collaborative

Requires enough space for two or more people to meet physically and to participate in meetings, with technology that enables collaboration with people in other locations. The activities can take place in an open or enclosed space, depending on the nature of the collaboration. Some activities include document creation and revision, coaching, conference calls, meetings, one-on-ones and impromptu chats with colleagues (examples of work settings where these

activities can take place in are offices, meeting rooms and open collaboration areas).

#### Gathering

Requires enough space for larger groups to gather away from work settings to reduce auditory and visual distractions. Some activities include meetings, town halls, eating, socializing and learning in groups (examples of work settings that these activities can take place in are meeting rooms and working lounges).

#### Benefits of the new way working are:

- » Better **collaboration** opportunities;
- » Better **interactions** across teams and colleagues;
- » More choice and variety in work settings;
- » A less sedentary and more **active** workstyle;
- » Helps foster an equitable **workplace culture**; and
- » Better utilization of office space.

### 2.1.2 Neighbourhoods

Some offices may be organized by “neighbourhood.” A neighbourhood is a designated area within the office for team members in a division or branch to easily find one another.

Employees may not be required to stay within their neighbourhood. Instead, they may work in other neighbourhoods to meet, collaborate and work with fellow colleagues and fully optimize the range of work settings in the office.

#### Benefits of Neighbourhood Planning include:

- » Fosters a sense of community;
- » Supports Activity-based Working;
- » Supports unassigned seating in a variety of work settings;
- » Convenience for finding people within the office workplace; and
- » Enables employee interaction, integration and knowledge transfer.

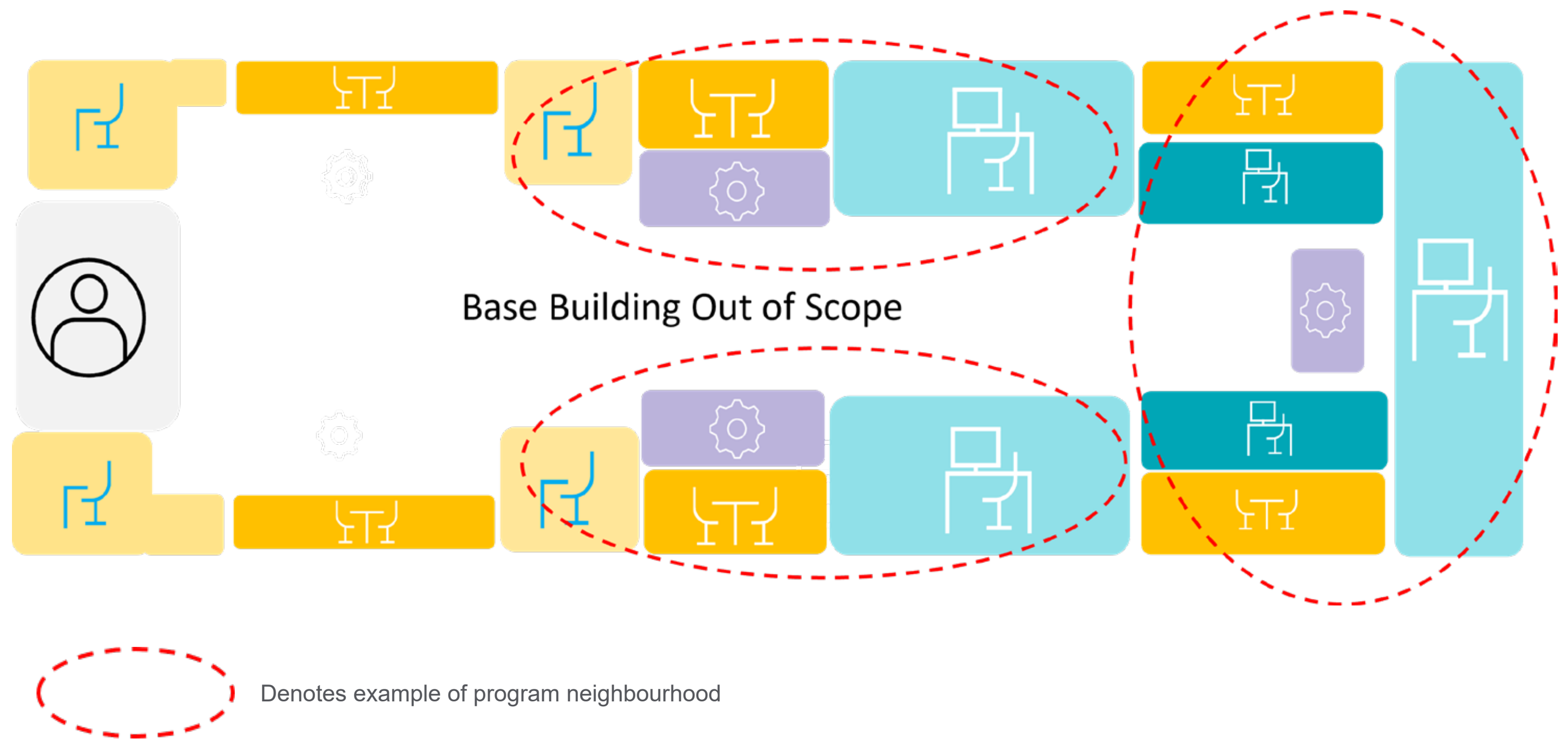

### 2.1.3 Adjacency Principles

It is important for the workplace to meet the needs of a variety of job roles, support different interactions among employees and provide the right work settings for each type of activity. Therefore, wherever possible, an office workspace and alternative workspace, whether enclosed or open, must have adjacency principles that address ergonomics, acoustics, and lighting.



#### Open Workspaces

Prioritize access to daylight, height-adjustable worksurfaces and incorporate sound masking (to help drown out background distractions and conversations), where possible.



#### Enclosed Workspaces

Adjacent to open workspaces and alternative workspaces (enclosed offices are to be planned on the interior (core walls) and not along perimeter windows), provide height-adjustable worksurfaces and sound baffles above dropped ceilings for noise absorption.

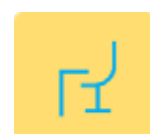

#### Open Alternative Workspaces

Special consideration to plan open alternative work settings away from open workspaces to reduce acoustic impact. Consider height-adjustable worksurfaces or furniture with a variety of heights and proximity to windows.



#### Enclosed Alternative Workspaces

Small enclosed alternative workspaces are to be adjacent to open work settings. Large enclosed alternative workspaces are to be planned in central locations which can be accessed by all. Implement furniture with a variety of heights and/or height-adjustable worksurfaces.



#### Support Spaces

Spaces beyond workspaces and alternative workspaces such as print/copy area, storage and filing areas/ rooms, and reception/welcome centre, etc.

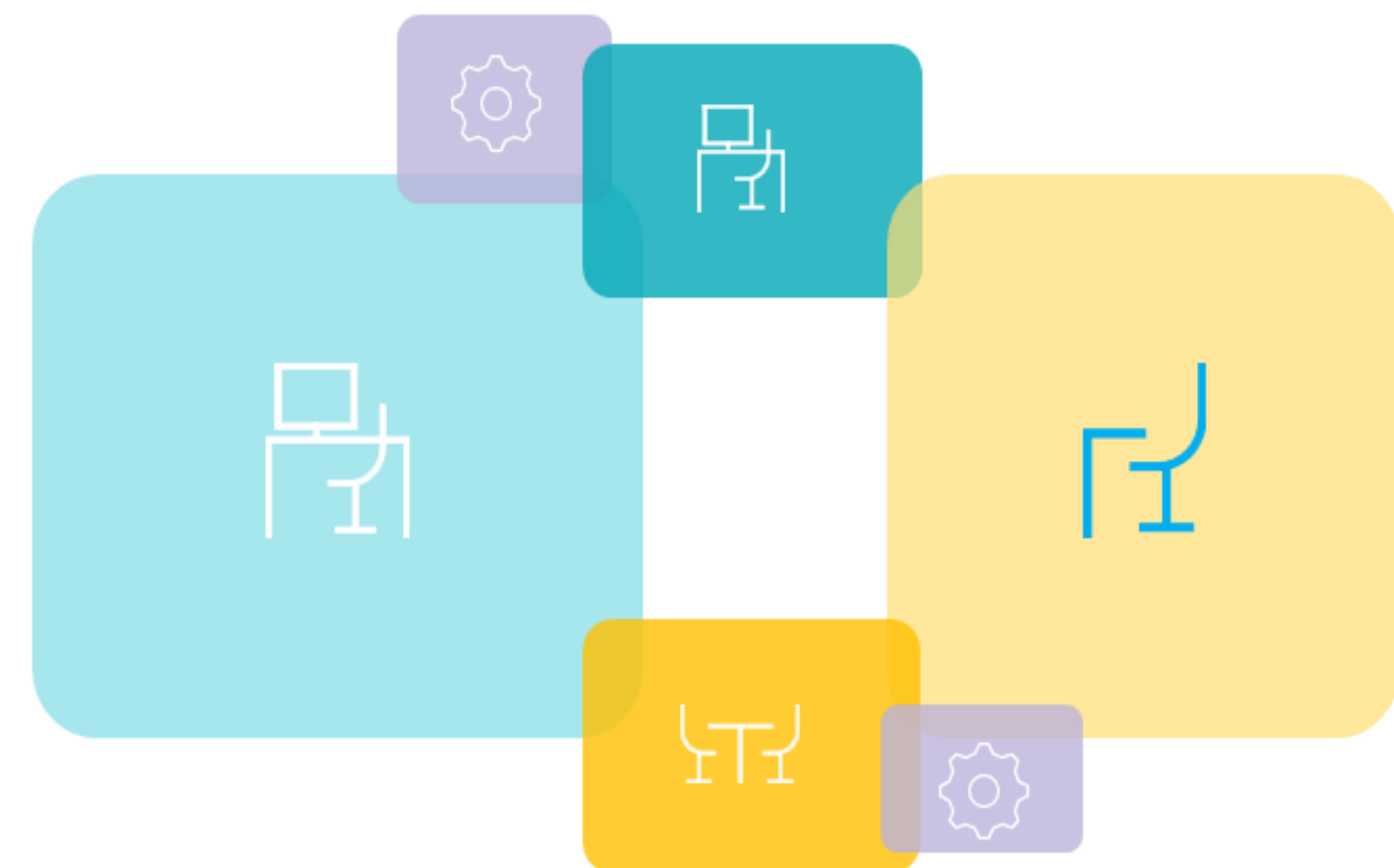

#### 2.1.4 Modularity

Modularity is a design approach that provides a flexible and adaptable environment for different work activities. This allows for greater flexibility and efficiency in the use of office space and can help improve productivity and collaboration among employees. The components can easily be rearranged or reconfigured to accommodate changing business objectives or quickly scaled up or down to fit teams of different sizes while saving time and money.

The use of modularity in designing space requires that power and data conduits be strategically placed in certain partitions. Through the strategic use of demountable partitions, timeframes and costs may be reduced for future reconfigurations. Further information can be found in the [“Concept of Flexibility is the Modular Approach”](#) section of the Kit of Parts.

#### 2.1.5 Workforce Block Floor Plans

Block floor plans illustrate the proposed locations, sizes and relationships or adjacencies between work settings. They are used for high-level planning; they are not detailed designs and do not provide details on design specifications.

There are three examples of workforce block floor plans that have been established to support program functionality and activity-based working for focusing, collaborating and gathering. Each workforce block floor plan illustrates an ideal distribution of work settings.

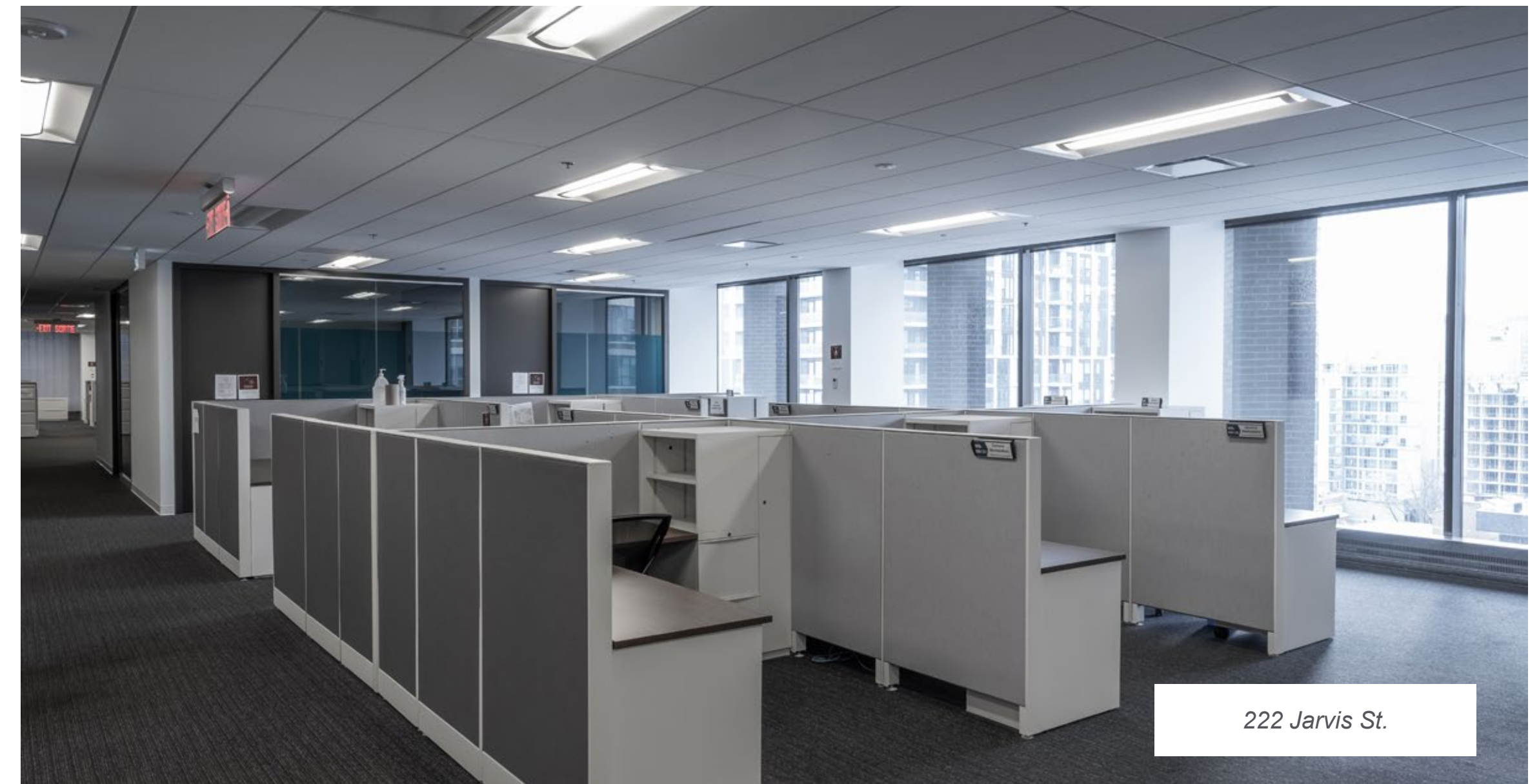
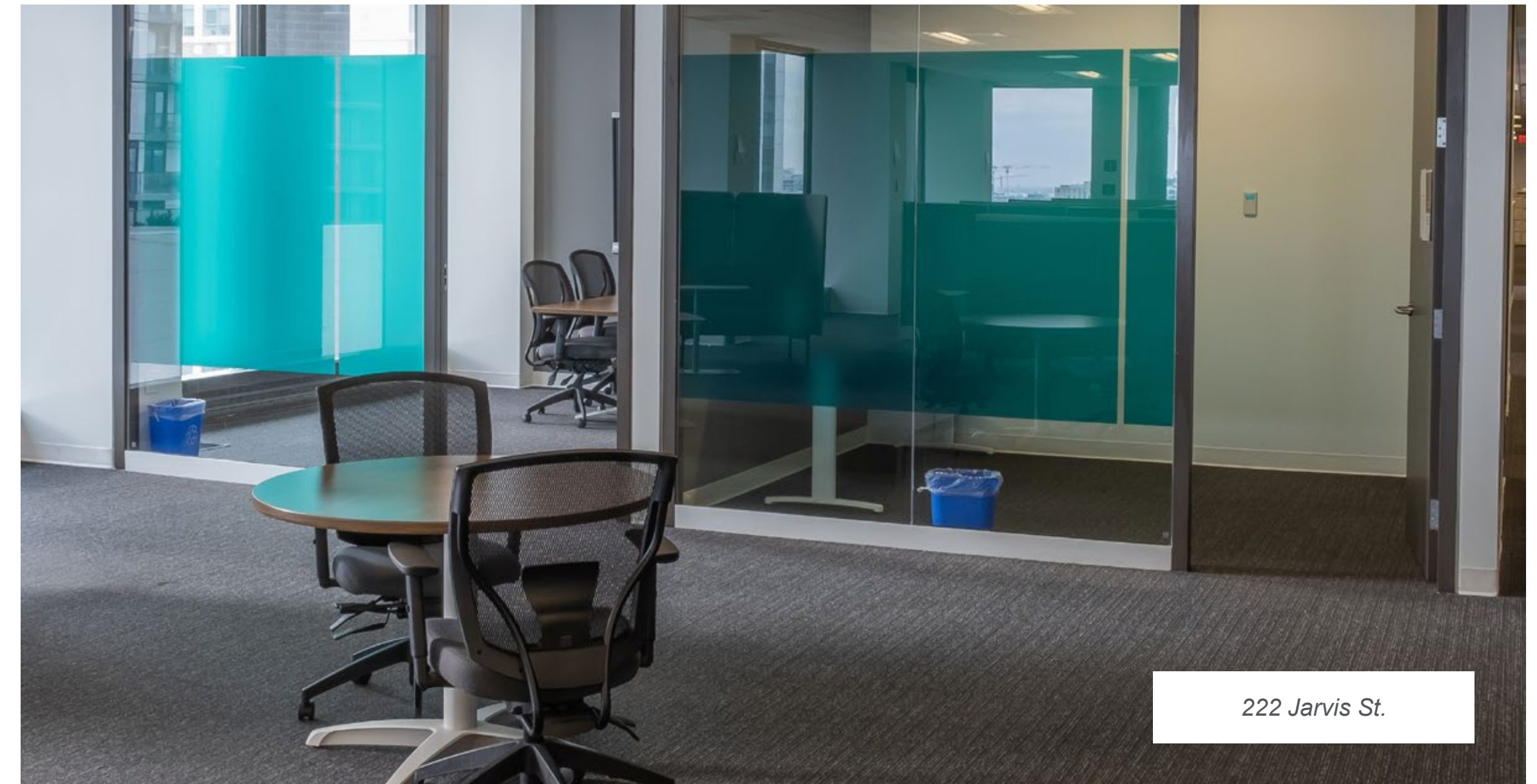
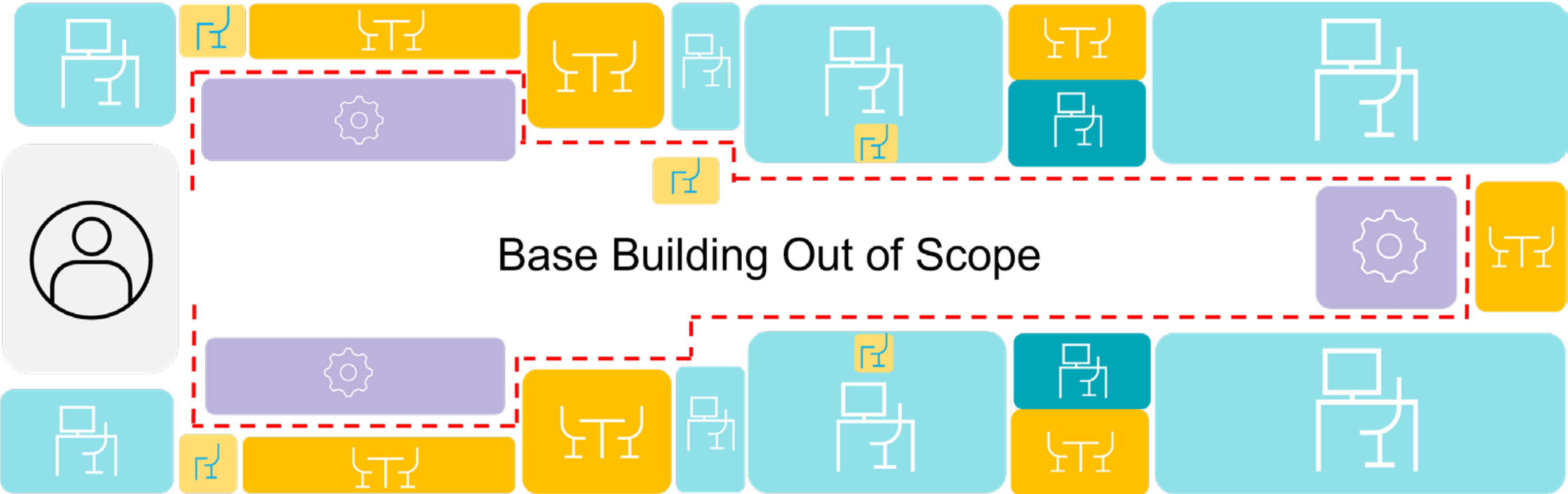

Figure 4: Example of a Focus Block Floor Plan. Prioritizes workspaces (offices and workstations) over collaborative spaces.

2.1.6 Workforce: Focus Block Floor Plan



Legend

- Common Shared Area
- Path of Travel (both directions)
- Open Workspaces: Prioritize access to daylight.
- Enclosed Workspaces: Adjacent to open work area.
- Open Alternative Workspaces: Seat types that support different focus / collaborative activities.
- Enclosed Alternative Workspaces: Acoustically separate collaboration spaces.
- Support Areas

\*Note: Floorplan is for illustration purposes only.

Percentage of Work Settings:



Figure 5: Example of a Balance Block Floor Plan. Includes an equal emphasis on workspaces and collaborative spaces.

2.1.7 Workforce: Balance Block Floor Plan

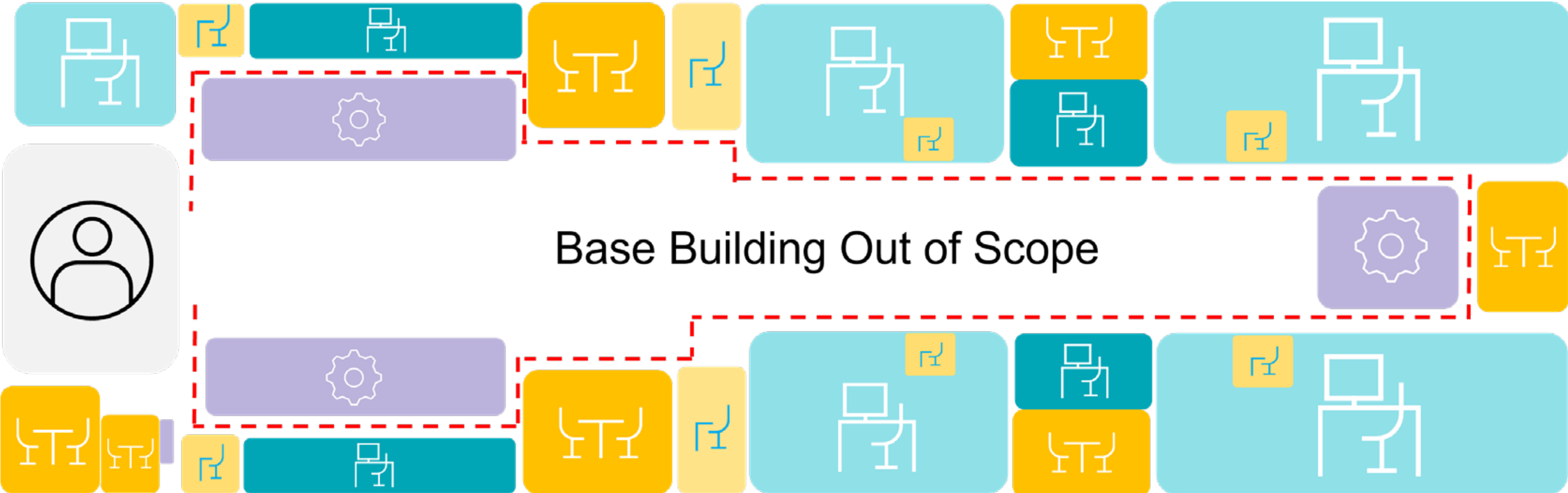

- Legend**
- Common Shared Area
  - Path of Travel (both directions)
  - Open Workspaces: Prioritize access to daylight.
  - Enclosed Workspaces: Adjacent to open work area.
  - Open Alternative Workspaces: Seat types that support different focus / collaborative activities.
  - Enclosed Alternative Workspaces: Acoustically separate collaboration spaces.
  - Support Areas

\*Note: Floorplan is for illustration purposes only.

Percentage of Work Settings:



Figure 6: Example of a Collaborative Block Floor Plan. Prioritizes collaborative spaces over workspaces.

2.1.8 Workforce: Collaborative Block Floor Plan

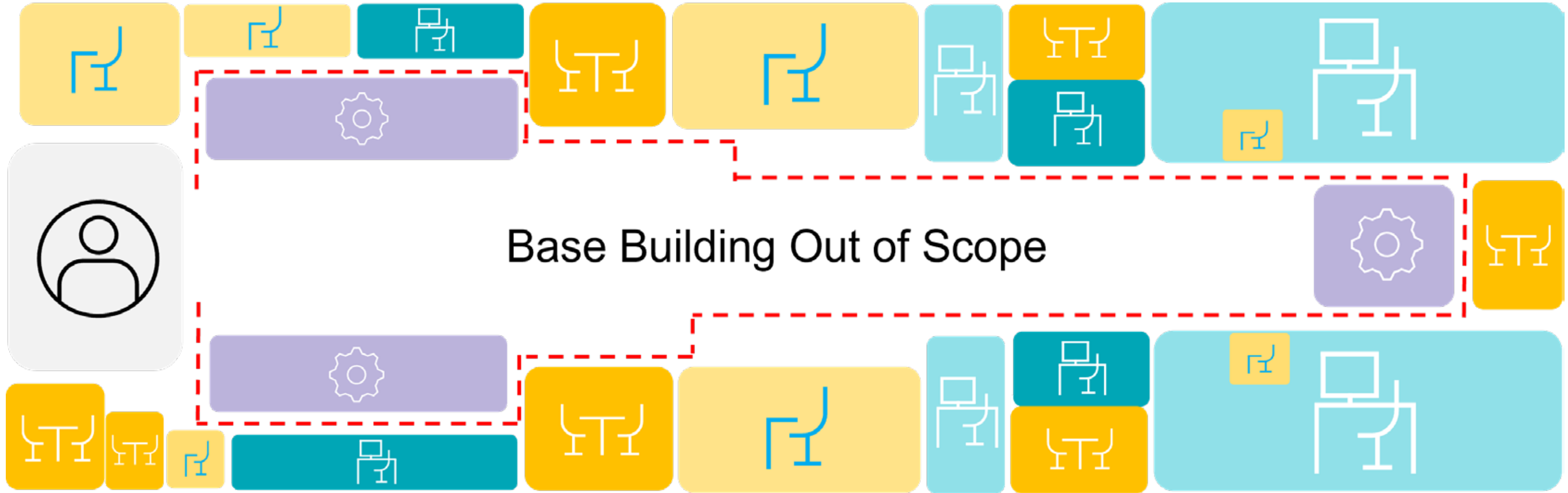

Legend

- Common Shared Area
- Path of Travel (both directions)
- Open Workspaces: Prioritize access to daylight.
- Enclosed Workspaces: Adjacent to open work area.
- Open Alternative Workspaces: Seat types that support different focus / collaborative activities.
- Enclosed Alternative Workspaces: Acoustically separate collaboration spaces.
- Support Areas

\*Note: Floorplan is for illustration purposes only.

Percentage of Work Settings:







## 3.0.0 KEY PLANNING CONSIDERATIONS

THE KEY PLANNING CONSIDERATIONS OUTLINE THE OVERALL PLANNING CONSIDERATIONS THAT SHOULD BE INCORPORATED INTO ALL OFFICE PROJECTS (WHERE APPLICABLE).

These considerations should be interwoven with design principles and key strategies outlined in sections 1 and 2.

- 3.1.0 Accessibility in the Built Environment
- 3.2.0 Accessible, Universal and Inclusive Design
- 3.3.0 Common Shared Spaces
- 3.4.0 Enabling an OPS Digital Workplace
- 3.5.0 Information, Privacy and Archives: The Case for Change
- 3.6.0 Heritage
- 3.7.0 Colour Strategy

222 Jarvis St.

## 3.1.0 ACCESSIBILITY IN THE BUILT ENVIRONMENT

Having an accessible environment requires anticipating, identifying and removing barriers so that anyone can access the built environment, regardless of their individual circumstances and needs to deliver a truly inclusive workplace.

Accessibility is defined and governed by the following guidelines, codes, standards and legislations. These governing rules are used in conjunction with each other to inform the delivery of accessible spaces. When there is a conflict between these rules, primacy is always assigned to the highest legislation.

The Accessibility for Ontarians with Disabilities Act (AODA), including the Design of Public Spaces Standards; the Ontario Building Code (OBC); and, the OPS Guidelines for Barrier-Free Design should be observed as the guiding rules and principles to inform planning when new facilities are built or substantially renovated in the Government of Ontario.

Additionally, it should be noted that these rules and guidelines, as outlined below, represent the minimum general criteria and can be referenced as a starting point to inform further improvements to accessible infrastructure design and planning.

### 3.1.1 Accessibility for Ontarians with Disabilities Act (AODA):

The [AODA](#) is a law that governs the process for developing and enforcing accessibility standards. The AODA takes direction from the Ontario Human Rights Code. Other legislation and guidelines (i.e. OBC, OPS Guidelines for Barrier-Free Design, etc.) provide more technical support to accessibility and the removal of barriers in the built environment. In the context of the OPS Modern Office Space standards, it is one of the overarching pieces of legislation that

informs aspects of accessible space design.

Many elements of the Accessibility Standards for the Built Environment that affect the design of buildings and their interiors are enforced through the OBC effective January 1, 2015.

The AODA governs standards that influence the design of space in five areas:

1. Customer Service
2. Employment
3. Information and Communication
4. Transportation
5. Design of Public Spaces (Accessibility Standards for the Built Environment)

Each of these standards provides regulations for removing barriers for employees and visitors with disabilities accessing government facilities.

### 3.1.2 Design of Public Spaces Standards

[Accessibility for Ontarians with Disabilities Act](#) 2005, O. Reg. 191/11 Integrated Accessibility Standards (IASR), PART IV.1, 413/12, s. 6., Design of Public Spaces Standards.

The most recent version of the Design of Public Spaces Standards should be consulted when determining the design, renovation, or construction of public spaces. The Design of Public Spaces Standards applies to any public spaces, whether newly constructed or redeveloped (extensive renovations per the OBC); however, it is not retroactive and does not apply to public spaces or portions of

public spaces that remain untouched. The Design of Public Spaces Standards requirements do not include areas covered by the OBC but work together with the OBC. This standard includes:

- » Outdoor paths of travel (i.e. sidewalks, ramps, stairs);
- » Accessible parking;
- » Service elements (i.e. service/info counters, fixed queuing lines, waiting areas); and
- » Maintenance and restoration of public spaces.

### Extensive Renovations:

Definition per OBC: Substantially removing existing building's interior wall, ceiling, floor, or roof assemblies and installing new interior wall, ceiling, floor and roof assemblies. This applies to base building structures.

### 3.1.3 Ontario Building Code

[Building Code Act](#), 1992, S.O. 1992, c. 23, O. Reg. 332/12: Building Code, O. Reg. 88/19, s. 97, Ontario Building Code, Section 3.8 Barrier-Free Design, with 2022 amendments.

The OBC applies to the design and construction of any new building system or extension of an existing building system. It defines accessibility requirements for the newest construction and extensive renovations of buildings and includes requirements for barrier-free paths of travel, fire safety devices, public washrooms, access to pools and saunas, seating in public spaces, etc. Its objectives include:

### **Accessibility**

To limit the probability that, as a result of the design or construction of a building, a person with a disability will be unacceptably impeded from accessing or using the building or its facilities.

#### **Accessibility – Barrier-Free Path of Travel**

To limit the probability that, as a result of the design or construction of a building, a person with a disability will be unacceptably impeded from accessing or circulating within it.

#### **Accessibility – Barrier-Free Facilities**

To limit the probability that, as a result of the design or construction of a building, a person with a disability will be unacceptably impeded from using the building's facilities.

The code defines that “barrier-free” means when applied to a building and its facilities, that the building and its facilities can be approached, entered and used by persons with disabilities.

The OBC is updated frequently, and the most recent version should be consulted when determining the design, renovation, or construction of a building or facility within a building. Its requirements do not include areas covered by the Design of Public Spaces Standards; rather, the requirements set out in the OBC are designed to work in conjunction with the Design of Public Spaces.

### **3.1.4 Guidelines for Barrier-Free Design of Ontario Government Facilities**

#### [The Guidelines for Barrier-Free Design of Ontario Government Facilities](#)

provide an outline of the minimum general requirements and design principles for accessible design, which must be considered when new facilities are constructed, or existing facilities are substantially renovated.

The guidelines are intended as an outline and defer to the OBC (as amended) and should always be referenced for any specific and/or mandatory specifications. They are reviewed annually to support compliance with the OBC and are updated periodically to reflect applicable changes.

The guidelines primarily address base building requirements, such as areas accessible to the public and may not apply to non-public areas of special purpose facilities. The guidelines should be applied to support project planning and design that is as accessible as possible.

Beyond the guidelines, the OPS recognizes that individual Disability Employment Accommodation Plans may require additional changes to facilities to prevent, remove or mitigate barriers for employees with disabilities.



315 Front St. W

## 3.2.0 ACCESSIBLE, UNIVERSAL, AND INCLUSIVE DESIGN

---

When it comes to office design/redesign, Accessible, Inclusive and Universal Design are all closely linked and strive to create spaces that reflect and respond to the diverse needs of their potential users. While all three approaches strive to ensure the usability of spaces, it is important to note where there are similarities and differences. Below are definitions for Accessible, Universal and Inclusive Design. Each of the principles and goals of these approaches has an impact on the user experience of persons with disabilities.

**Accessible Design** anticipates, identifies and removes barriers for persons with disabilities through standards and regulations, including the Ontario Human Rights Code, the Accessibility for Ontarians with Disabilities Act, the Canadian Standards Association Accessible Design for the Built Environment and the Ontario Building Code. It represents the minimum criteria for making design accessible for users with disabilities.

**Universal Design** is the design and composition of an environment so that it can be accessed, understood and used to the greatest extent possible by all people regardless of their age, size, ability, or disability. It focuses on providing a single solution that serves the most extensive possible user base (NC State University, The Center for Universal Design, 1997). There are seven principles of Universal Design and eight goals of Universal Design listed below.

**Inclusive Design** is a process that includes user input in the design process itself and that considers the full range of human diversity with respect to ability, language, culture, gender, race, age and other forms of human difference. This approach aims to include a diverse group of people who have varying

abilities and disabilities, personal preferences and other forms of differences. While universal design focuses on a single solution to serve the most extensive possible user base, inclusive design may involve several solutions to meet a diverse group of needs. Further, inclusive design is an iterative process that seeks to update and adapt the product to respond to changing user needs.

Architects and designers should reference the following resources when designing inclusive office environments: the Seven Principles of Universal Design, the Eight Goals of Universal Design and the Three Dimensions of Inclusive Design. Below is a summary and link to each resource.

### 3.2.1 The Seven Principles of Universal Design

The [Seven Principles of Universal Design](#) were developed in 1997 by a working group of architects, product designers, engineers and environmental design researchers, led by the late Ronald Mace at North Carolina State University. The design team should follow these principles when thinking about the project at its initial stages to promote inclusivity to serve end users, regardless of the user or their ability.

- » **Principle #1 - Equitable Use:** The design is useful and marketable to people with diverse abilities.
- » **Principle #2 - Flexible Use:** The design accommodates a wide range of individual preferences and abilities.
- » **Principle #3 - Simple and Intuitive Use:** The use of the design is easy to understand, regardless of the user's experience, knowledge, language skills, or current concentration level.
- » **Principle #4 - Perceptible Information:** The design communicates necessary

information effectively to the user, regardless of ambient conditions or the user's sensory abilities.

- » **Principle #5 - Tolerance for Error:** The design minimizes hazards and the adverse effects of accidental or unintended actions.
- » **Principle #6 - Low Physical Effort:** The design can be used efficiently and comfortably with a minimum of fatigue.
- » **Principle #7 - Size and Space for Approach and Use:** Appropriate size and space are provided for approach, reach, manipulation and use regardless of the user's body size, posture, or mobility.

### 3.2.2 The Eight Goals of Universal Design

[The Eight Goals of Universal Design](#) were developed to expand Universal Design's original focus to include human performance, social participation and health and wellness. The goals define the outcomes of Universal Design practice in ways that can be measured and applied to all design domains within the constraints of existing resources. The goals encompass functional, social and emotional dimensions. Each goal is supported by an interdisciplinary knowledge base of anthropometrics, biomechanics, perception, cognition, safety, health promotion and social interaction. (Steinfeld and Maisel, 2012, University of Buffalo). The Eight Goals of Universal Design are:

- » **Body Fit:** Accommodating a wide range of body sizes and abilities.
- » **Comfort:** Keeping demands within desirable limits of body function and perception.
- » **Awareness:** Ensuring that critical information for use is easily perceived.
- » **Understanding:** Making methods of operation and use intuitive, clear and unambiguous.

- » **Wellness:** Contributing to health promotion, avoidance of disease and protection from hazards.
- » **Social Integration:** Treating all groups with dignity and respect.
- » **Personalization:** Incorporating opportunities for choice and the expression of individual preferences.
- » **Cultural Appropriateness:** Respecting and reinforcing cultural values and the social and environmental contexts of any design project.

### 3.2.3 The Three Dimensions of Inclusive Design

[The Three Dimensions of Inclusive Design](#) was developed by the Inclusive Design Research Centre at OCAD University. It sets out high-level principles (broken down into three dimensions) and how they can be applied to digital design as well as the design of services, the built environment and physical products. The dimensions focus on:

1. Recognizing diversity and uniqueness (mass solutions to diverse needs do not work).
2. Creating inclusive processes and tools (gathering inclusive teams with a diverse range of expertise and lived experience, using inclusive tools in design processes).
3. Driving broader beneficial impacts (striving to benefit beyond the intended beneficiaries of the design).

The three approaches above should be referred to and implemented whenever possible in each design. They offer guidelines and best practices for designing to ensure that the office environment can meet the needs of future users.



### 3.3.0 COMMON SHARED SPACES

Common shared spaces (e.g. quiet rooms, ceremonial rooms, and wellness/first aid rooms) serve a diverse range of user needs and are critical to modern workplaces. As a leader committed to supporting excellence in accessibility and diversity and inclusion within the office workplace, the OPS strives to incorporate accessible, inclusive and universal design when creating the design elements for these spaces:

- » **Quiet rooms:** An inclusive and comfortable space for OPS employees to use in a quiet manner for reflection, contemplation, meditation or personal prayer during the workday.
- » **Ceremonial rooms:** Can be used to accommodate Indigenous and other Sacred Ceremonies, as well as meetings and training sessions.
- » **Wellness/First Aid rooms:** A dedicated space intended to promote self-care and wellness that supports and enhances the physical and mental well-being of OPS employees, as well as providing first aid services. The design follows the Revised Regulations of Ontario (RRO) Reg. 1101: (First Aid Requirements) as a dedicated first aid room is required in buildings/complexes with 200 or more employees.

Partners across the OPS were engaged in collaborative discussions to gather user-centric feedback. Prior project experiences and industry best practices, both within and outside the OPS, were also taken into account to inform the design elements of these spaces. An ongoing collaborative approach, involving subject matter experts, partners, stakeholders and the broader organizational community, is applied to the OMOS as it undergoes an annual review, ensuring an iterative approach to continuous improvement.



### 3.4.0 ENABLING AN OPS DIGITAL WORKPLACE

Technology continues to remain a critical element when designing and working within a modern workplace. Digital initiatives are transforming our workplace. The [OPS GO-ITS 80 standards](#) for cabling and wiring for voice and data communications in government buildings must be followed when designing an OPS workplace. The GovTechON digital workplace strategy equips the OPS with digital tools and service options, on modernized IT infrastructure. This enables a consistent work experience with the added flexibility in how we work in the office while ensuring data and systems are protected.

The GovTechON digital workplace vision allows employees to stay connected anytime, anywhere in the office workplace, with the right supporting infrastructure, furniture and devices to meet business needs.

**Key aspects to transform and enable an OPS Digital Workplace include:**

- » **Connectivity:** Enable the connectivity level required for speed and access to data and applications at OPS work locations in support of data/video needs.
- » **Capacity:** Leverage collaborative meeting space technology and expanded Wi-Fi coverage to maximize available spaces and align with MOI's office realty model.
- » **Collaboration:** Support both in-person collaboration and connecting people across many locations. Rapid changes in technology are enabling the transformation of government programs and services to continue meeting public expectations.
- » **Communication:** Provide ready and timely access to multi-media information that will equip staff with guiding principles, best practices and other resources when considering their business and technology needs.



## 3.5.0 INFORMATION, PRIVACY AND ARCHIVES: THE CASE FOR CHANGE

In addition to other current processes and to support an effective Digital Workplace, Records and Information Management (RIM) need to be implemented and/or aligned.

The OMOS enterprise design standards place increased emphasis on electronic document management with limited centralized filing for business-related items, prioritizing work settings for people over space for storage. By redesigning space to have less storage and focusing on digital records management, where feasible, fewer storage options are required, enabling an easier transition to the digital future.

### 3.5.1 Records Management is Important for Office Transformation

Key aspects of RIM include an emphasis on:

- » **Records Digitization:** Helps to save costs and frees up space in the workspace that can be used for other means.
- » **Going Paperless:** Do you need to print what you're printing? The records management team can help you understand what documents can be discarded and which can be safely stored for later use.
- » **Revising Retention Schedules:** Retention schedules can be revised to enable early destructions, as well as transferring active/semi-active records to storage to save space.
- » **Unscheduled Records:** Don't have a schedule, but need to get your boxes out? Information, Privacy Archives can store unscheduled records until a retention schedule is put in place.

### 3.5.2 Benefits of Electronic Document Management

- » Improve response times to requests for records and supports OPS service delivery.
- » Maximize use of space if files are available digitally versus physical boxes.
- » Drive efficiency and cost avoidance through the sharing, integration and re-use of information and data and by keeping information and data only as long as required.

It is important to consult with Ministry RIM leads to access supports available and explore options to e-file and digitize records, including reviewing retention schedules. For additional resources, please visit the links below:

- » [Information Storage and Retrieval Services - InsideOPS \(ontario.ca\)](#)
- » [Recordkeeping, Access and Privacy Advisory Services - InsideOPS \(ontario.ca\)](#)
- » ["You are not starting from scratch": Getting Started on Implementing Information and Data Governance - InsideOPS \(ontario.ca\)](#)





### 3.6.0 HERITAGE

---

Heritage, both built structures and in an archaeological context, is an important consideration in designing and modifying our spaces. Properties owned or controlled by the Province may be identified as having cultural heritage value or interest under the Ontario Heritage Act, making them subject to the Standards and Guidelines for Conservation of Provincial Heritage Properties (2010). The architecture of the building, the surrounding landscape and interior attributes may hold cultural heritage value and therefore, consideration must be given to their conservation. Decision makers must make best efforts to integrate heritage attributes of a property when designing, modifying, or altering a space or feature.

The role of the third-party heritage consultant or the IO Heritage team (in partnership with MOI, Ministry of Citizenship and Multiculturalism and ministry subject matter experts) is to:

- » If not already completed, assess the cultural heritage value of the property and identify the cultural heritage value and heritage attributes in the workplace;
- » Ensure all heritage work is undertaken by qualified persons with appropriate expertise in the specific project or change being proposed is based on an approved Statement of Cultural Heritage Value and Strategic Conservation Plan (when one is in place);
- » Undertake necessary studies to inform and support decisions, such as a Strategic Conservation Plan and/or Heritage Impact Assessments and consult appropriately on such studies;
- » Use heritage best practices when designing, modifying, or altering an identified heritage space or feature, supported by recognized guidance such as the Standards and Guidelines for the [Conservation of Historic Places in Canada \(2010\)](#); and

- » Balance the needs of the people, the purpose of the project and the conservation of heritage throughout the design process.



Macdonald Block

### 3.7.0 COLOUR STRATEGY

Just as “heritage” speaks of the past, the intended approach to colour strategy is to help clearly bridge the past and the present. As colours are a key factor in creating unity and coherence within our work environment, the colour strategy sets out a palette that echoes Ontario’s natural magnificence. The common loon with its distinct black and white plumage, the shades of green found in our diverse forests of birch, poplar, spruce and tamarack trees, and the deep blues from our vast interconnected lakes, rivers and streams are reflected through the various furniture offerings and finishes.

This colour strategy is designed to be applicable across a spectrum of projects to be applied in various refresh, rework and reconstruct projects. Application of the colour strategy should take into consideration:

- » **Aesthetics Synchronization:** alignment with existing furniture elements to promote a sense of cohesion and harmony in the workplace, especially for refresh and rework projects.
- » **Sensory Balance:** balancing between vibrant and calming hues to provide an environment that stimulates creativity and productivity while maintaining a sense of tranquillity.

By incorporating the iconic nature colour strategy into the design elements of the office workplace, the OPS aims to embrace Ontario’s natural beauty and provide an environment that brings about productivity, creativity and well-being.

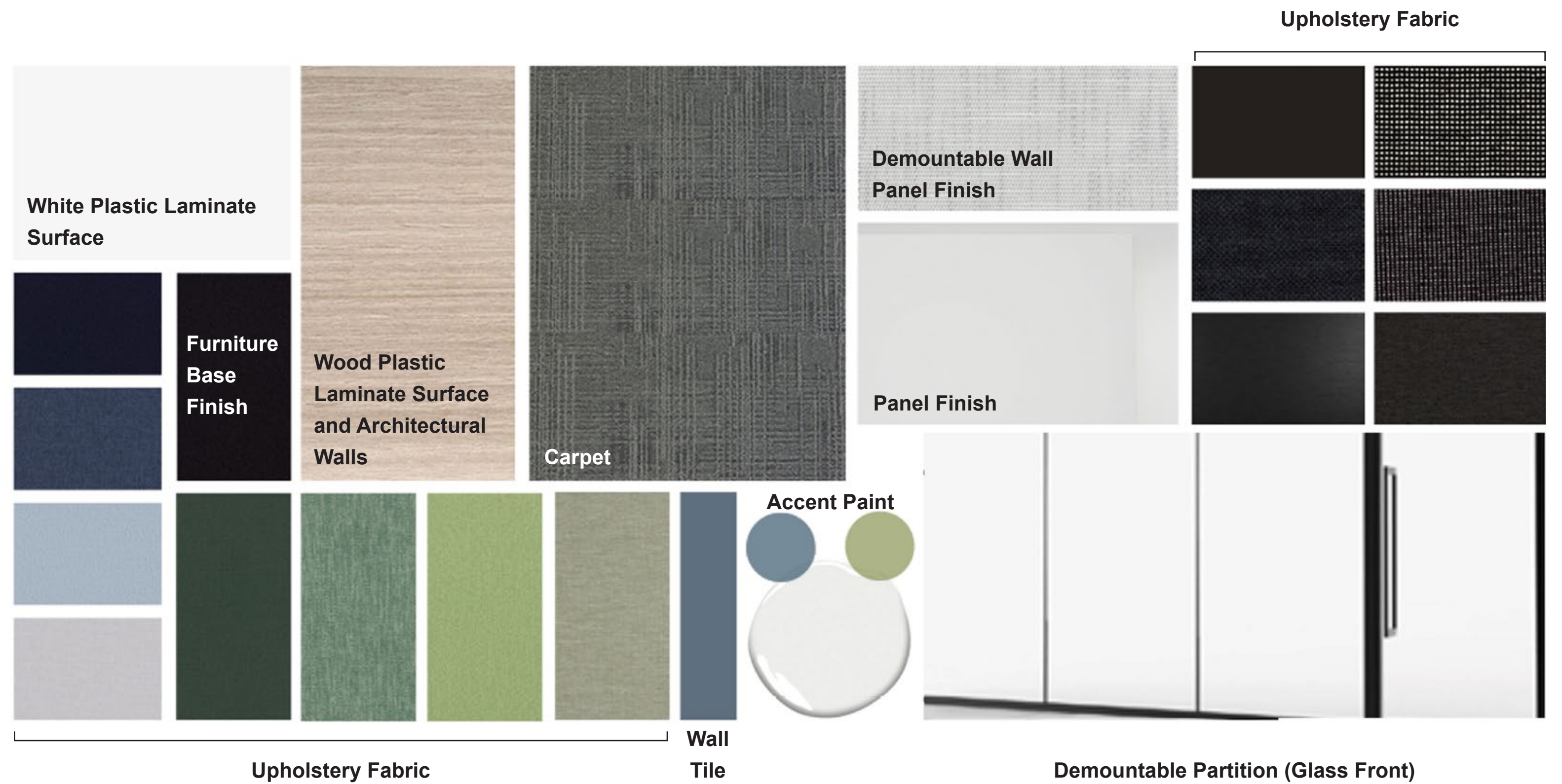



315 Front St. W

## 4.0.0 KIT OF PARTS (KOP)

THE KIT OF PARTS (KOP) IS A COLLECTION OF APPROVED STANDARDS WITH A VARIETY OF WORK SETTINGS THAT CAN BE APPLIED TO ALL OFFICE WORKPLACES.

The KOP is the building blocks to be used in a variety of ways to create OPS office workspaces that best reflect a program's space needs.

- 4.1.0 About the KOP
- 4.2.0 Accessibility Space Standards
- 4.3.0 Workforce Work Setting Adjacencies
- 4.4.0 Concept of Flexibility is the Modular Approach
- 4.5.0 Iconic Nature Colour Strategy
- 4.6.0 Workspaces
- 4.7.0 Alternative Workspaces (Enclosed)
- 4.8.0 Alternative Workspaces (Open)
- 4.9.0 Support Areas
- 4.10.0 Common Shared Spaces

## 4.1.0 ABOUT THE KOP

---

The Kit of Parts (KOP) is divided into two separate documents, the workforce KOP (further described below) and the executive KOP. Each workspace, alternative workspace and support space in both KOPs is described by size, accessibility, furniture, infrastructure requirements and its adjacency/location in an office layout.

The workforce KOP outlines typical office work settings that encompass workspaces, alternative workspaces and support spaces. These work settings can be combined to create OMOS standards that accommodate a range of activities in the workplace and offers choice and flexibility. The workforce refers to all ministry employees.

The workforce KOP is organized into three sections:

- » **Workspaces:** Workstations and offices.
- » **Alternative Workspaces:** A combination of open and enclosed spaces that support the new way of working by providing spaces for collaboration. Open alternative workspaces do not have walls and are set up for informal impromptu meetings, while closed alternative workspaces have walls and are usually set up for more formal meetings or when privacy is required. Examples include 60-Minute Rooms, meeting rooms, break-out rooms, working lounges/ lunchrooms collaboration spaces, etc.
- » **Support Areas:** Areas that are not intended for focus or collaboration but are needed for office functions. These spaces include but are not limited to, locker areas, coat closets, storage, print/copy rooms, etc.

The KOP for executive space is a separate addendum to the OMOS to ensure the confidentiality of the executive space, plan and design. While distribution will remain limited, the executive KOP can be shared with the necessary project team members as required when designing the space. The executive KOP outlines typical office work settings and support spaces and refers to the following roles within the Government of Ontario: Ministers, Associate Ministers, Parliamentary Assistants, Deputy Ministers, Chiefs of Staff and corresponding support staff.



## 4.2.0 ACCESSIBILITY SPACE STANDARDS

---

### 4.2.1 Clearances

#### Doors and Doorways:

Maneuvering space at doors should be clear of any obstacles and not overlap with any fixtures, furniture or other parts of the built environment.

- » 1200 mm (3'-9") x 1200 mm (3'-9") on the push side of the door
- » 1500 mm (5'-0") x 1500 mm (5'-0") on the pull side of the door

#### Turning Circles:

Should be provided at key decision points in paths of travel and in all areas with dead-end conditions to provide adequate space for a person to turn around without having to back up.

Turning Circles should always be clear of any obstruction or overlap with any fixed fixtures, furniture or other parts of the built environment for their full height.

- » 2500 mm (8'-2") turning circle where noted, and as good practice (i.e. Increased Accessible 60-minute Room)
- » 1500 mm (5'-0") turning circle at minimum [2100 mm (6'-8") preferable] (i.e. 60-Minute Room, Offices, Meeting Rooms etc.)

#### Clear Floor Space:

Clear Floor Space should follow building code and be provided in front of all:

- » Controls such as light switches, push buttons for power operated doors or window blinds
- » Amenities such as waterpoints and coffee stations
- » Appliances such as fridges and microwaves
- » Workplace features and tools, such as technical equipment and whiteboards

All Clear Floor Spaces should be located on an accessible path of travel and should always be clear of any obstruction or overlap with fixtures, furniture or any path of travel.

Clear floor areas to be clear of any obstruction for their full height.

- » Forward approach: 1500 mm (5'-0") x 900 mm (2'-9")
- » Side approach: 2200 mm (7'-2") x 900 mm (2'-9")

#### Chair Space:

Where seating is provided at tables, allocate a clear space of 600 mm (1'-10"), measured out from the workstation, table, or counter to allow for space taken up by a person seated. Measure all pathways from the edge of the chair space.

### 4.2.2 Interior Pathways

#### General:

Hallways, corridors and other circulation spaces should be designed to accommodate everyone. Turning circles should be provided at key decision points in paths of travel and in all areas with dead-end conditions.

#### Dead Ends:

Design pathways so that they avoid dead ends, including pathways that end in a doorway. Where dead ends are longer than 3 m (9'-8"), provide a 2100 mm (6'-8") turning circle, as a best practice. Note: Currently OBC requirement is 1800 mm (5'-8") for every 30 m (98'-0").

#### Obstacles:

Where obstacles such as structural columns are located within pathways, they must only limit the clear width to not less than 950 mm (3'-0") wide for not more than 615 mm (2'-0") in length and open to the minimum required width for the pathway on both sides of the obstruction. Ensure objects do not protrude more than 100 mm (3.9") into paths of travel unless they extend low enough (680 mm max) to be detected by a cane.

#### Primary Pathways:

To be at least 1600 mm (5'-2") in width. Primary Pathways are intended for frequent, two-way travel, allowing two people using mobility devices to pass each other. Primary Pathways to connect with the main entry and main elevator lobby, and to avoid dead ends. 2500 mm (8'-2") turning circles to be provided at key decision points.

#### Secondary Pathways:

To be at least 1200 mm (3'-9") in width. Secondary Pathways are intended for frequent, one-way travel, allowing a person walking and a person using a mobility device to pass each other. This will also accommodate a person with a service animal. Secondary Pathways to connect with the Primary Pathways within 30 m (98'-4"). Where dead ends exist in Secondary Pathways, provide a 2500 mm (8'-2") turning circle.

#### Tertiary Pathways:

To be at least 1100 mm (3'-6"). Tertiary Pathways are intended for limited-occupant use, one-way travel and should connect with Secondary or Primary

Pathways within 30 m (98'-4"). Where dead ends exist in Tertiary Pathways, provide a 2500 mm (8'-2") turning circle.

**Workstation Pathways (Subsidiary Aisles):**

To be at least 1000 mm (3'-6") and include a 600 mm (1'-9") clearance for chair space so that space is provided for chair outside of the clear path. Where the Workstation Pathway serves more than eight (8) seats or is longer than 7.5 m (24'-7"), the Pathway must not terminate at a dead end without providing a 2100 mm (6'-8") turning circle at the dead end outside of workstation chair space. Alternately, provide a through-pathway to avoid an individual having to back up through the Workstation Pathway.

**Meeting Room Pathways – Accessible:**

To be at least 1000 mm (3'-6") and include a 600 mm (1'-9") clearance for chair space so that space is provided for a chair outside of clear path. Clear path must extend throughout the room to provide access to all services located within the meeting room, including white boards and any technology. Include a 2500 mm (8'-2") turning circle within the meeting room clear of the table and allocate a space outside of the accessible pathway for a chair to allow for clear space at the table.



### 4.2.3 Accessibility Space Standards

Clearances at doors:  
Clear floor space at doors  
should be clear of any furniture/  
obstacles

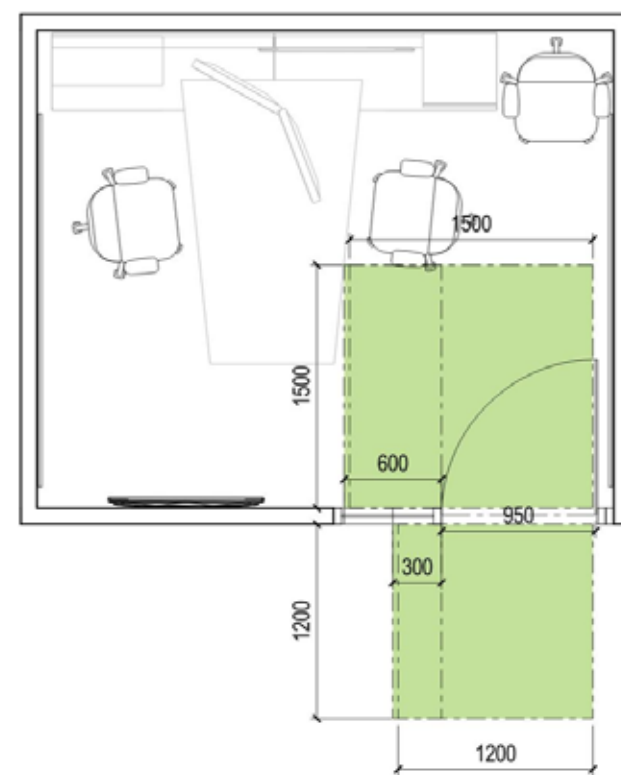

Clearances around meeting tables:

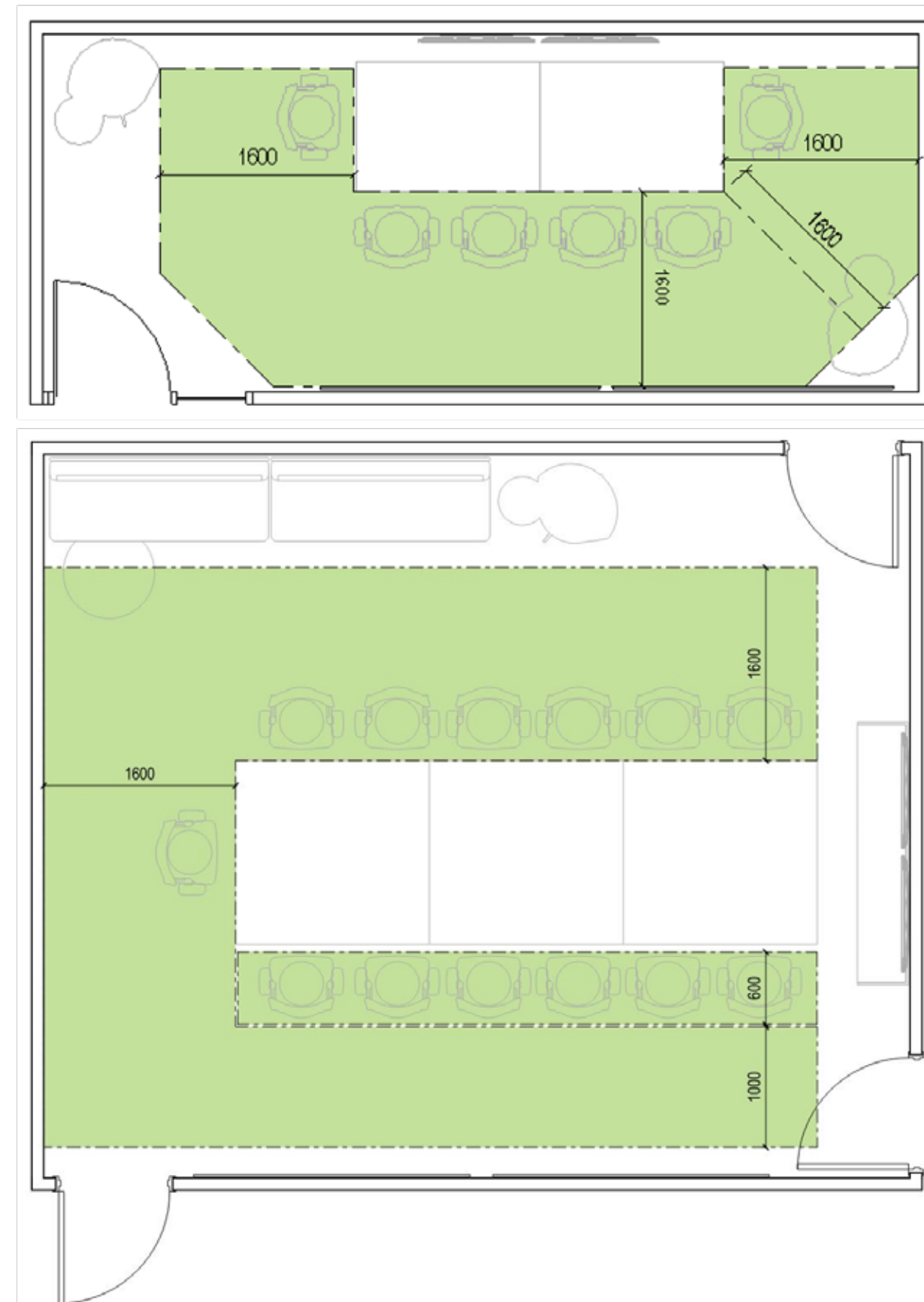

Clearances for accessible seating and service  
animals:

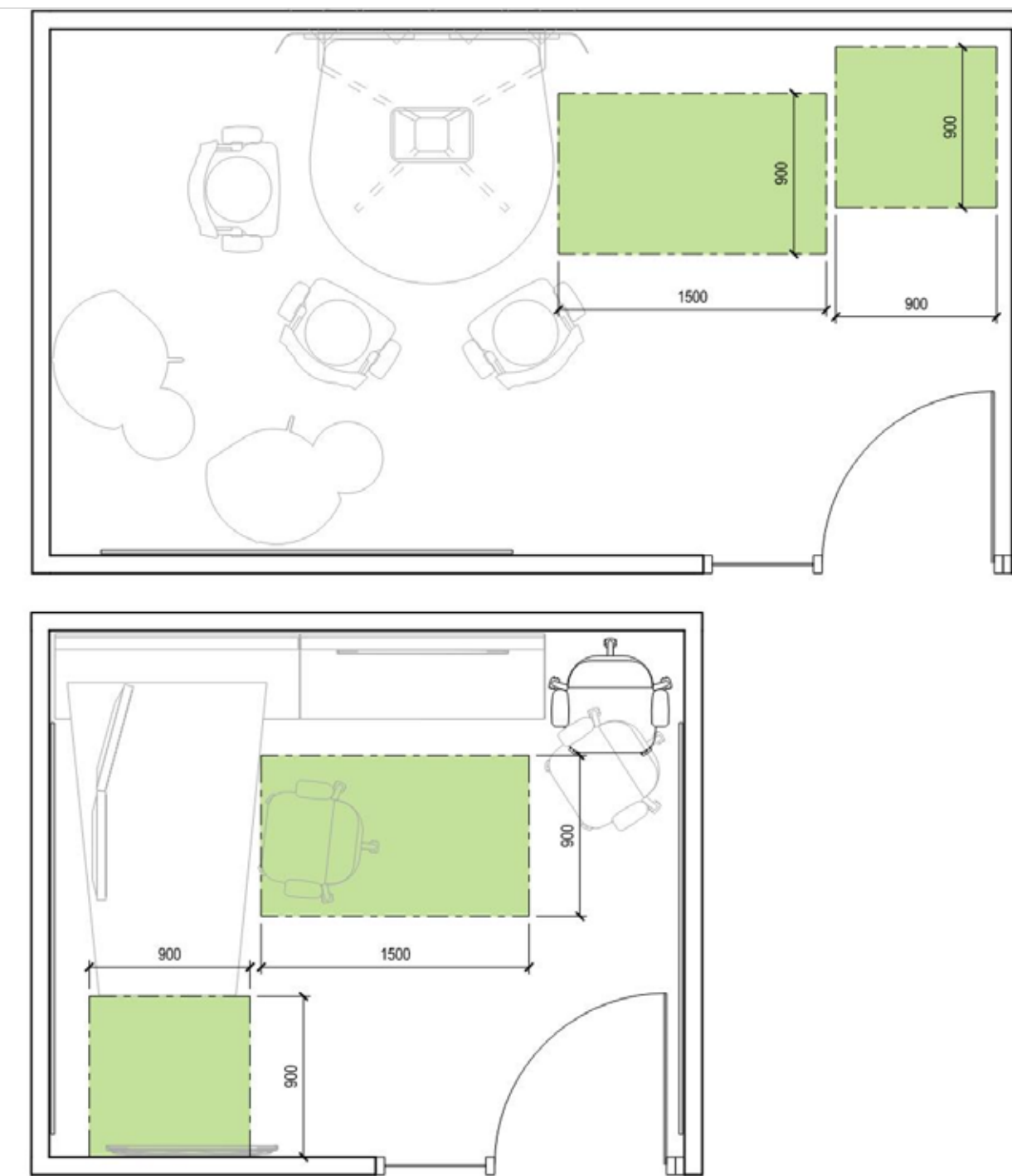

\*2D plans are for illustration purposes only, glass front  
locations and swing/slider doors could change depending on  
architectural fit of floor plates.

### 4.3.0 WORKFORCE WORK SETTING ADJACENCIES

By following these design planning principles, the office workspace and alternative workspace (whether enclosed or open) can meet ergonomic, acoustic, and lighting needs for a variety of job roles for each type of activity.



#### Open Workspaces

Prioritize access to daylight, height-adjustable worksurfaces and incorporate sound masking (to help drown out background distractions and conversations), where possible.



#### Enclosed Workspaces

Adjacent to open workspaces and alternative workspaces (enclosed offices are to be planned on the interior (core walls) and not along perimeter windows), provide height-adjustable worksurfaces and sound baffles above dropped ceilings for noise absorption.



#### Open Alternative Workspaces

Special consideration to plan open alternative work settings away from open workspaces to reduce acoustic impact. Consider height-adjustable worksurfaces or furniture with a variety of heights and proximity to windows.



#### Enclosed Alternative Workspaces

Small enclosed alternative workspaces to be adjacent to open work settings. Large enclosed alternative workspaces to be planned in central locations to be accessed by all. Implement furniture with a variety of heights and/or height-adjustable worksurfaces.



#### Support Areas

Spaces beyond workspaces and alternative workspaces such as print/copy area, storage and filing areas/ rooms, and reception/welcome centre, etc.

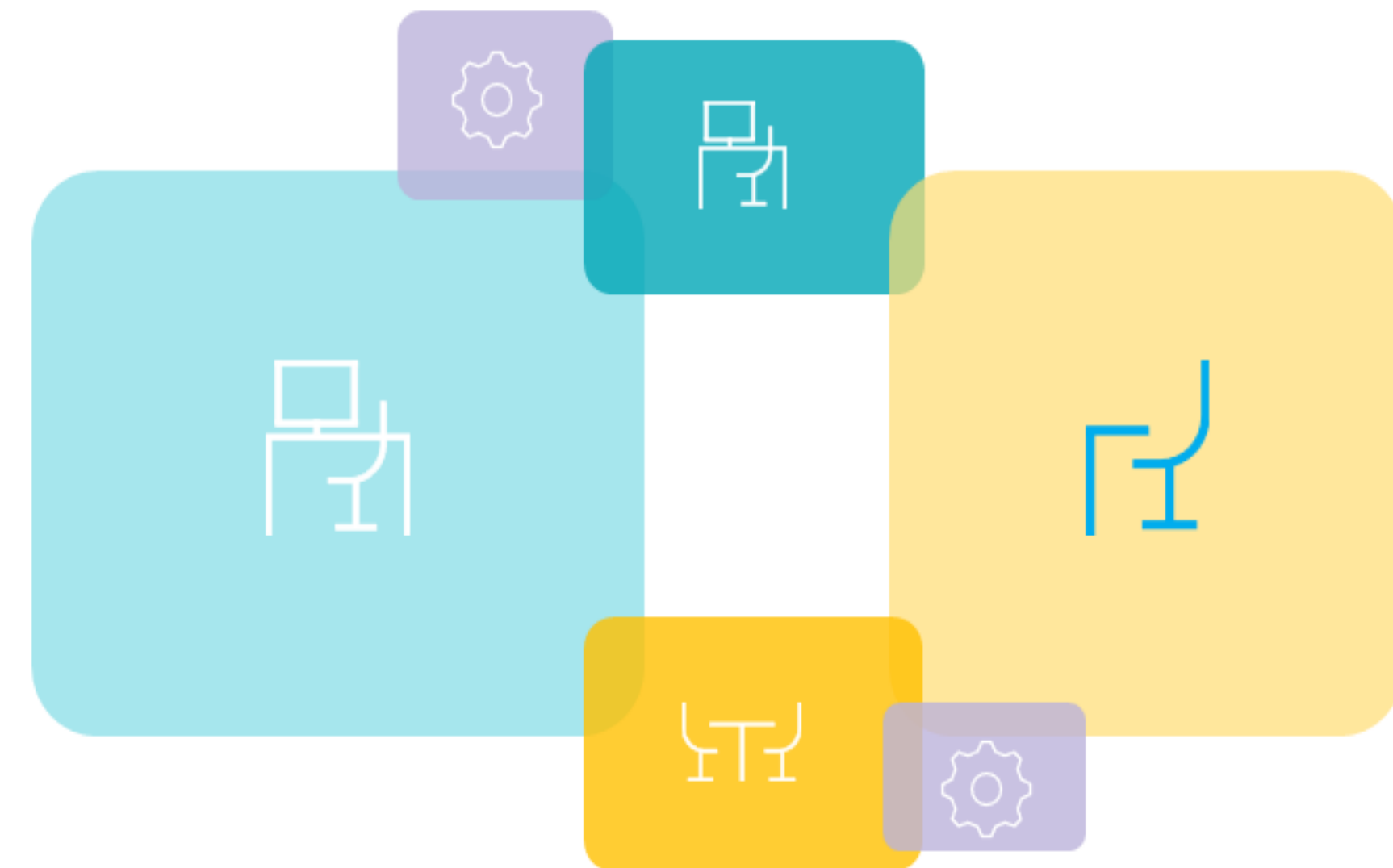









### 4.3.1 Workforce Work Setting Adjacencies: Focus Block Floor Plan

The plan is designed with collaborative work settings at the entrance of suite and progresses towards focused work settings.



#### Legend

-  Common Shared Area
-  Path of Travel (both directions)
-  Open Workspaces:  
Prioritize access to daylight.
-  Enclosed Workspaces:  
Adjacent to open work area.
-  Open Alternative Workspaces:  
Seat types that support different focus / collaborative activities.
-  Enclosed Alternative Workspaces:  
Acoustically separate collaboration spaces.
-  Support Areas

\*Note: Floorplan is for illustration purposes only.

#### Percentage of Work Settings:



### 4.3.2 Workforce Work Setting Adjacencies: Balance Block Floor Plan

The plan is designed with collaborative work settings at the entrance of suite and progresses towards focused work settings.

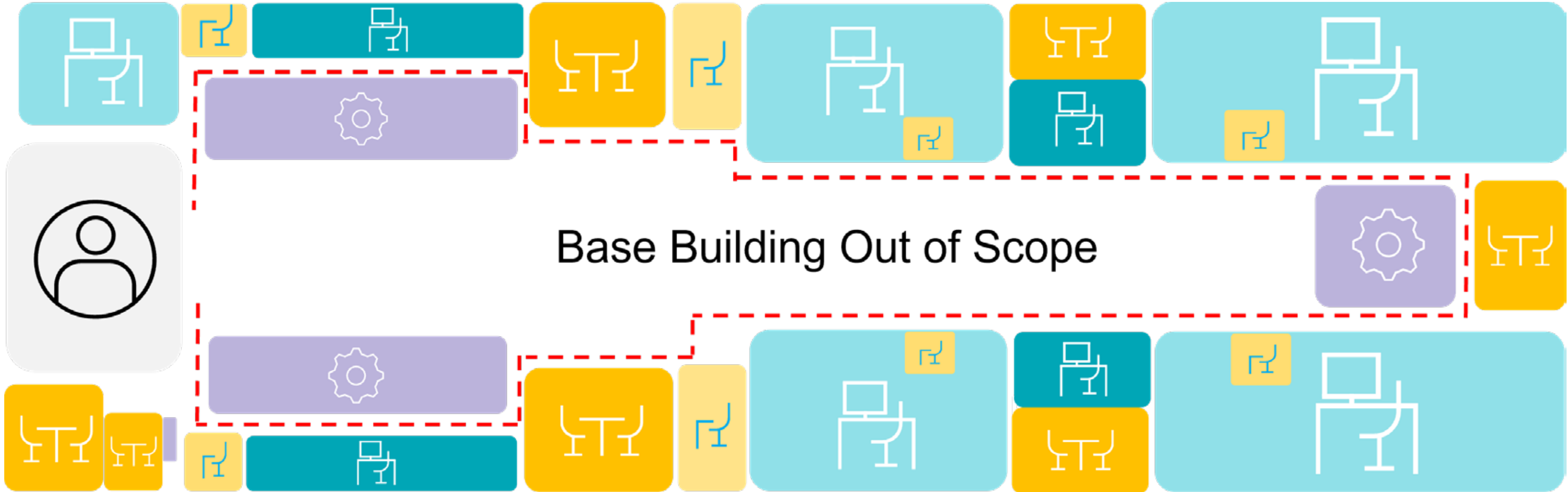

- Legend**
- Common Shared Area
  - Path of Travel (both directions)
  - Open Workspaces: Prioritize access to daylight.
  - Enclosed Workspaces: Adjacent to open work area.
  - Open Alternative Workspaces: Seat types that support different focus / collaborative activities.
  - Enclosed Alternative Workspaces: Acoustically separate collaboration spaces.
  - Support Areas

\*Note: Floorplan is for illustration purposes only.

**Percentage of Work Settings:**

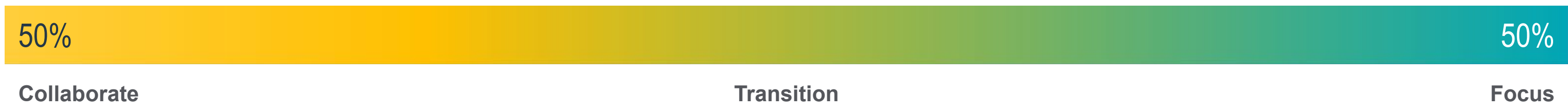





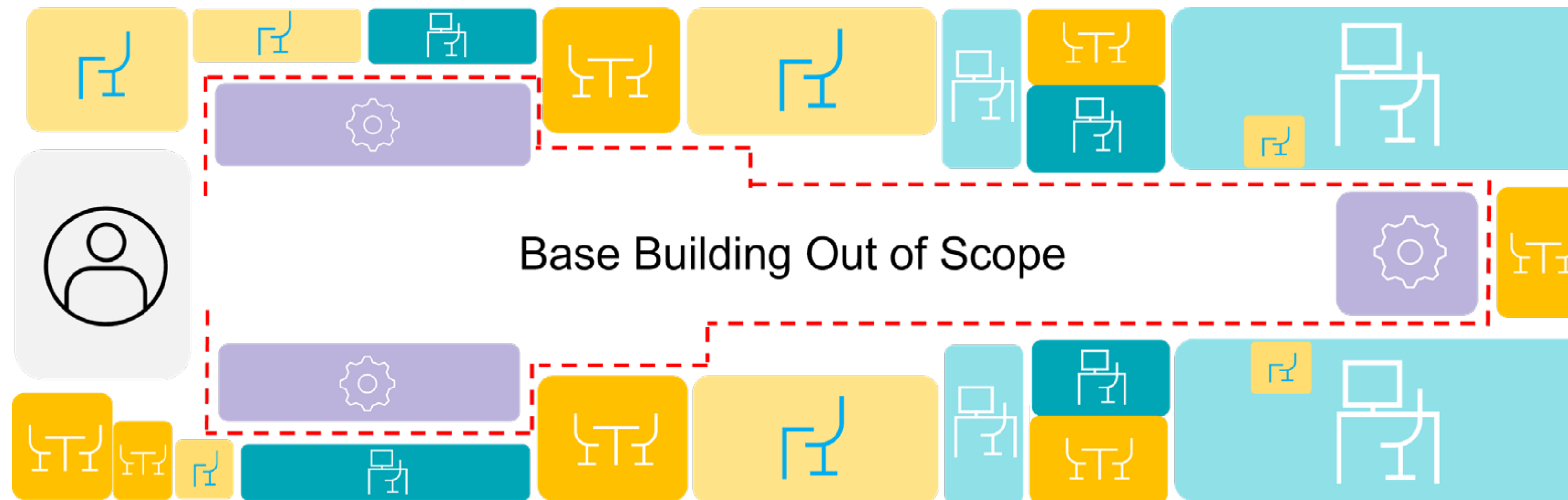

### 4.3.3 Workforce Work Setting Adjacencies: Collaborative Block Floor Plan

The plan is designed with collaborative work settings at the entrance of suite and progresses towards focused work settings.



#### Legend

-  Common Shared Area
-  Path of Travel (both directions)
-  Open Workspaces:  
Prioritize access to daylight.
-  Enclosed Workspaces:  
Adjacent to open work area.
-  Open Alternative Workspaces:  
Seat types that support different focus / collaborative activities.
-  Enclosed Alternative Workspaces:  
Acoustically separate collaboration spaces.
-  Support Areas

\*Note: Floorplan is for illustration purposes only.

#### Percentage of Work Settings:



### 4.4.0 CONCEPT OF FLEXIBILITY IS THE MODULAR APPROACH

A flexible office is a design approach that provides employees with a variety of different places and ways to work. To be easily **rearranged to accommodate changing business objectives** or quickly scaled up and down to fit teams of different sizes.

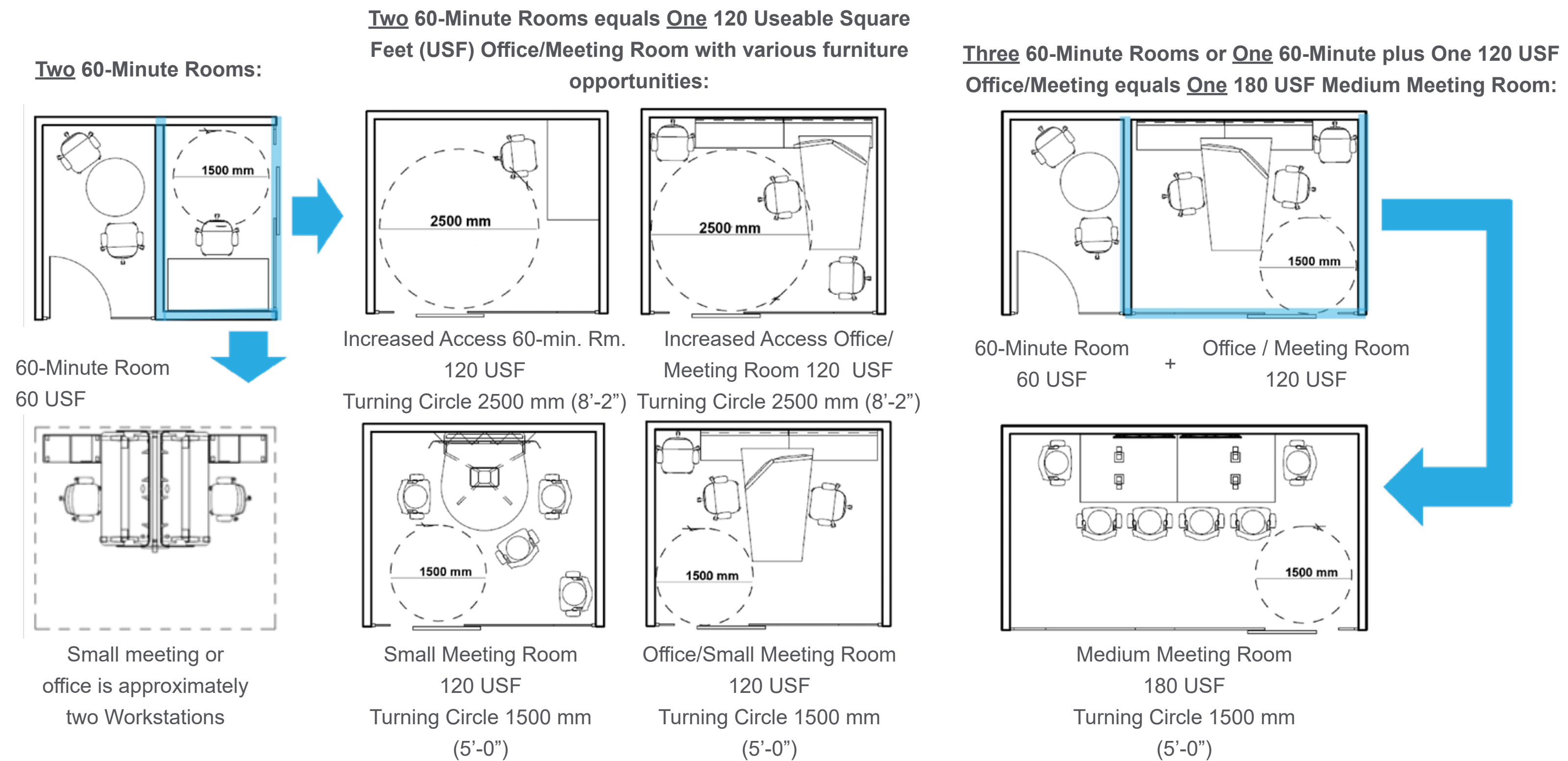

\*2D plans are for illustration purposes only, glass front locations and swing/slider doors could change depending on architectural fit of floor plates.

### 4.4.1 Concept of Flexibility

A flexible office is a design approach that provides employees with a variety of different places and ways to work. To be easily **rearranged to accommodate changing business objectives** or quickly scaled up and down to fit teams of different sizes.

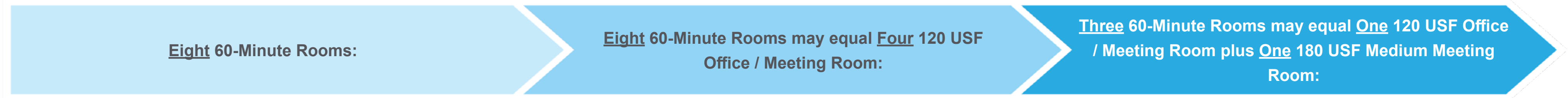

Demountable partition  
- can be adjusted as required to revise space

Demountable partition  
- Primary infrastructure wall that hosts power and data

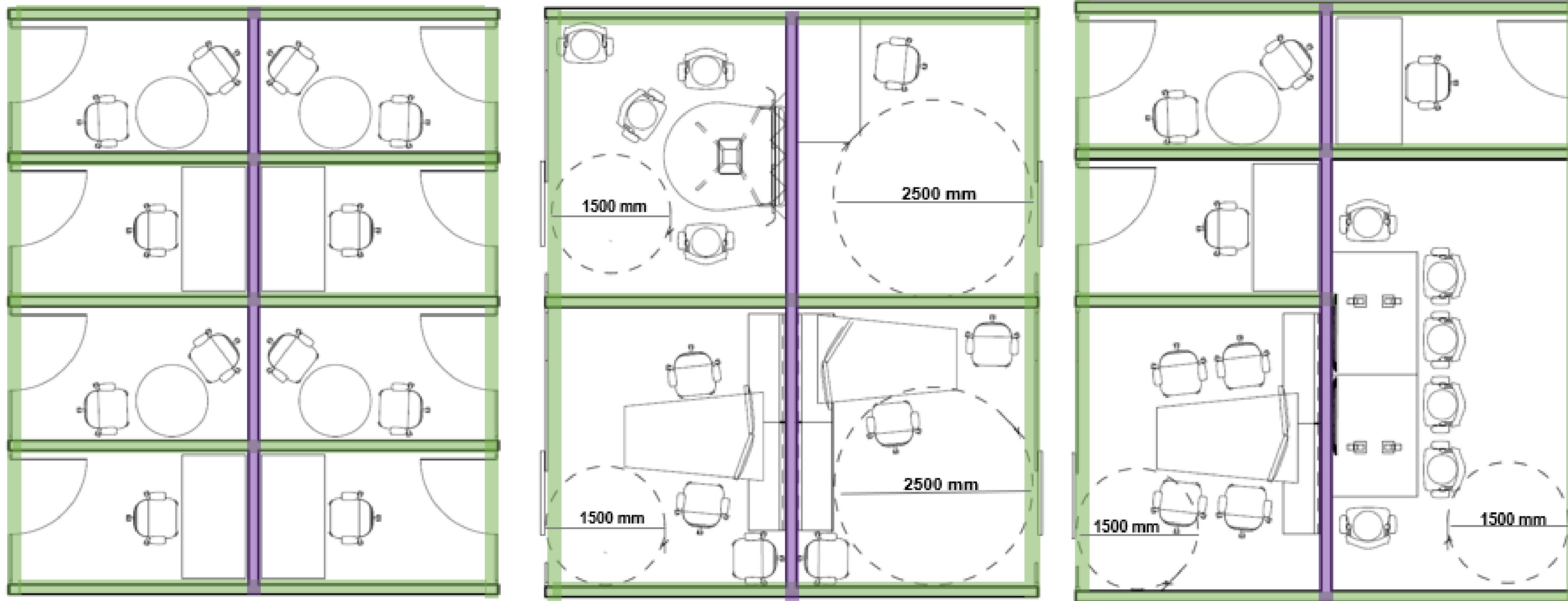

\*2D plans are for illustration purposes only, glass front locations and swing/slider doors could change depending on architectural fit of floor plates.

### 4.4.2 Concept of Flexibility Continued

A flexible office is a design approach that provides employees with a variety of different places and ways to work. To be easily **rearranged to accommodate changing business objectives** or quickly scaled up and down to fit teams of different sizes.

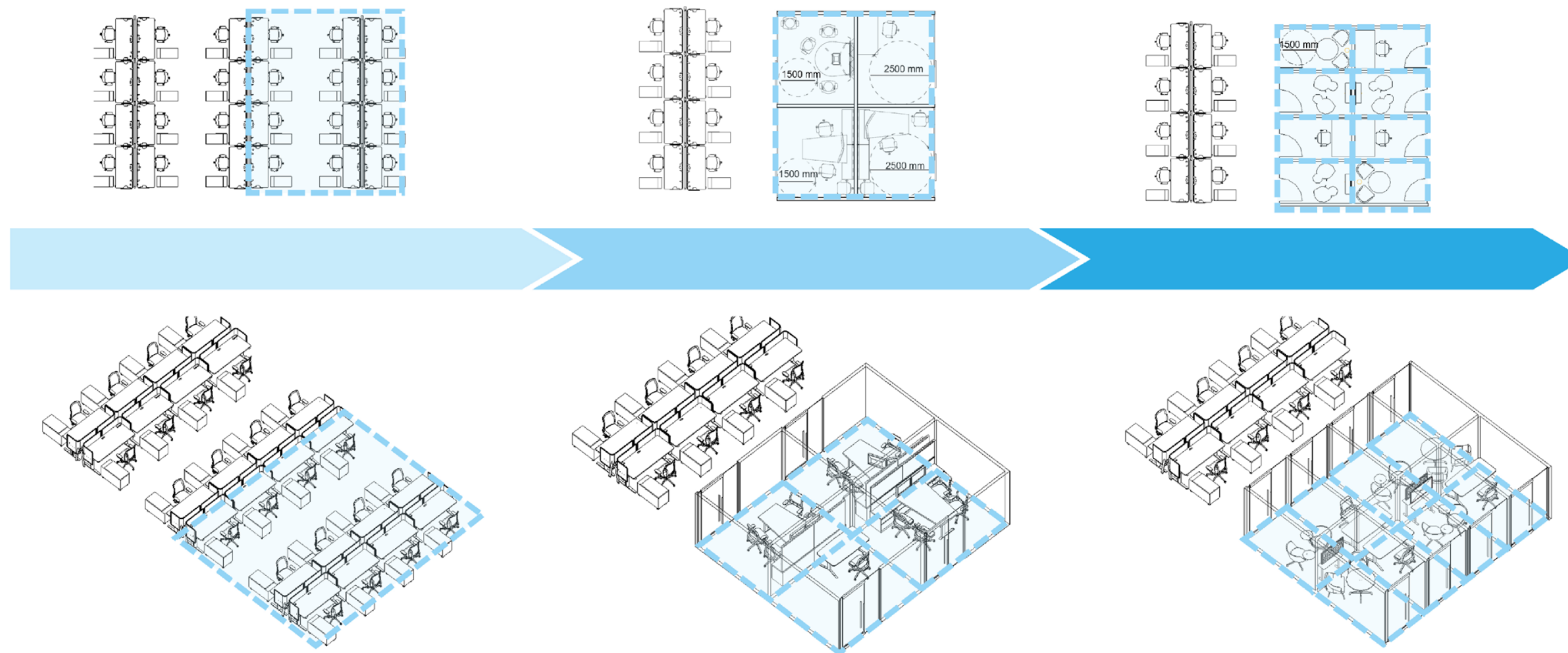

## 4.5.0 ICONIC NATURE COLOUR STRATEGY

This colour strategy should apply to all Refresh (limited changes), Rework (moderate changes) and Reconstruct (significant changes) projects. However, in the case of Refresh and Rework projects, careful consideration should be given to ensure harmonious alignment with existing furniture elements in order to promote a sense of cohesion and harmony in the workplace.

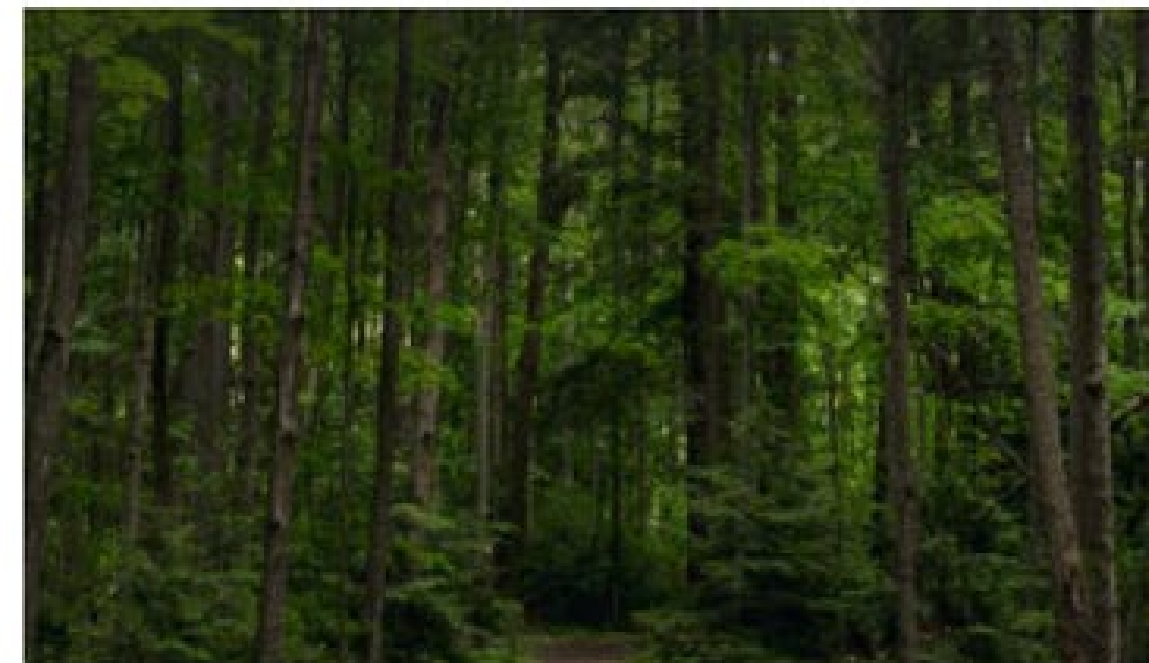
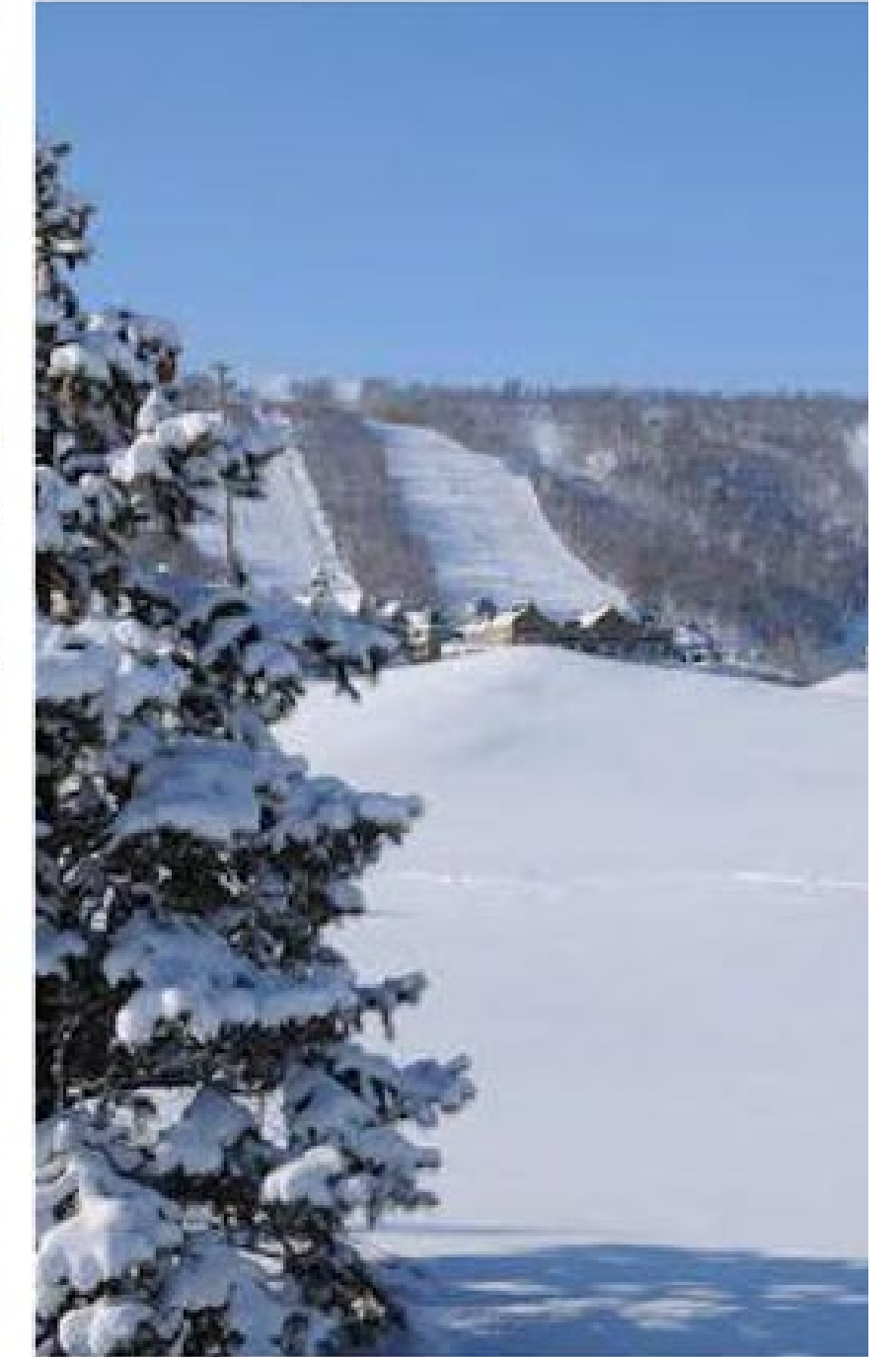
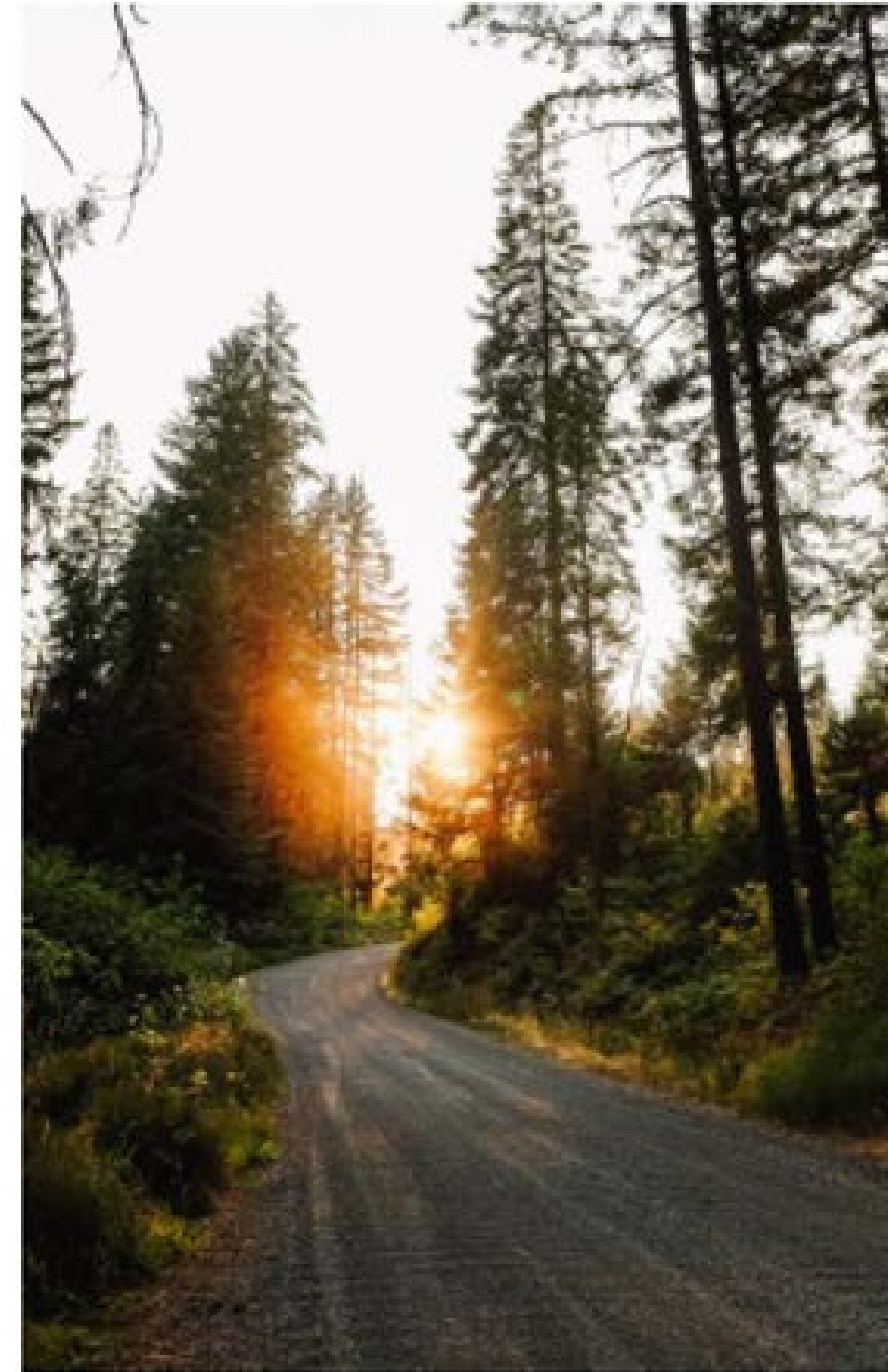

4.5.1 Iconic Nature Colour Strategy Finishes Palette

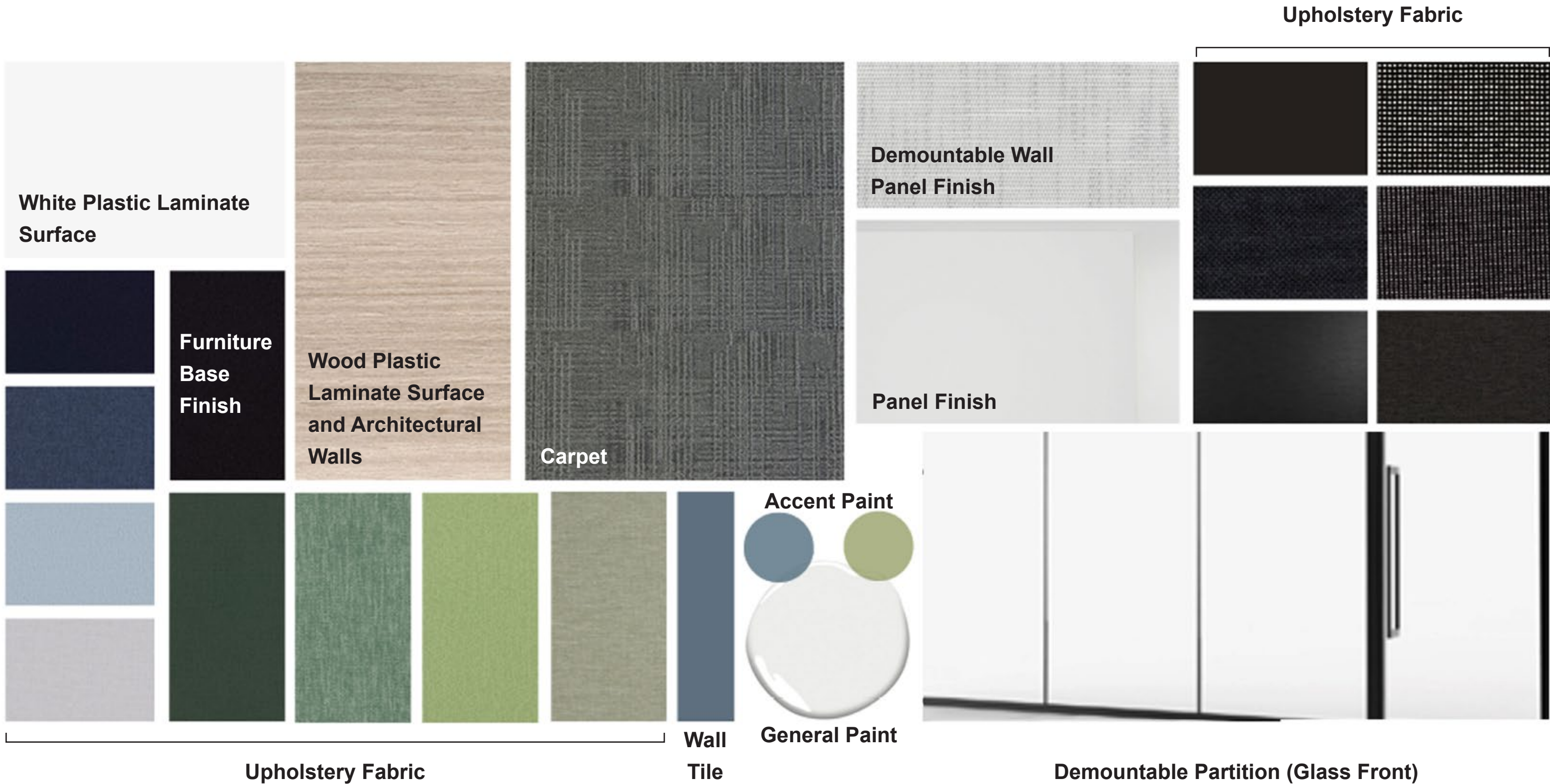

- » To ensure an enterprise approach across all OPS offices, when redesigning the space, transformation projects should apply the finishes palette to match as close as possible to the design intent of the colour strategy.
- » Please note, finishes and colour palettes are for reference only as fabrics and finishes are provided by various fabric manufacturers who partner with furniture manufactures and as such colour tones may vary.



### 4.5.2 Iconic Nature Colour Application: Workforce Floor Plan Overview

In the Iconic Nature colour strategy, complimentary hues of blue and green, are blended and grounded on warm woods, with blacks and whites added for contrast and practicality. The Floor Plan illustrates how the Iconic Nature colour strategy will be applied to furniture and architectural walls for a reconstruct project.

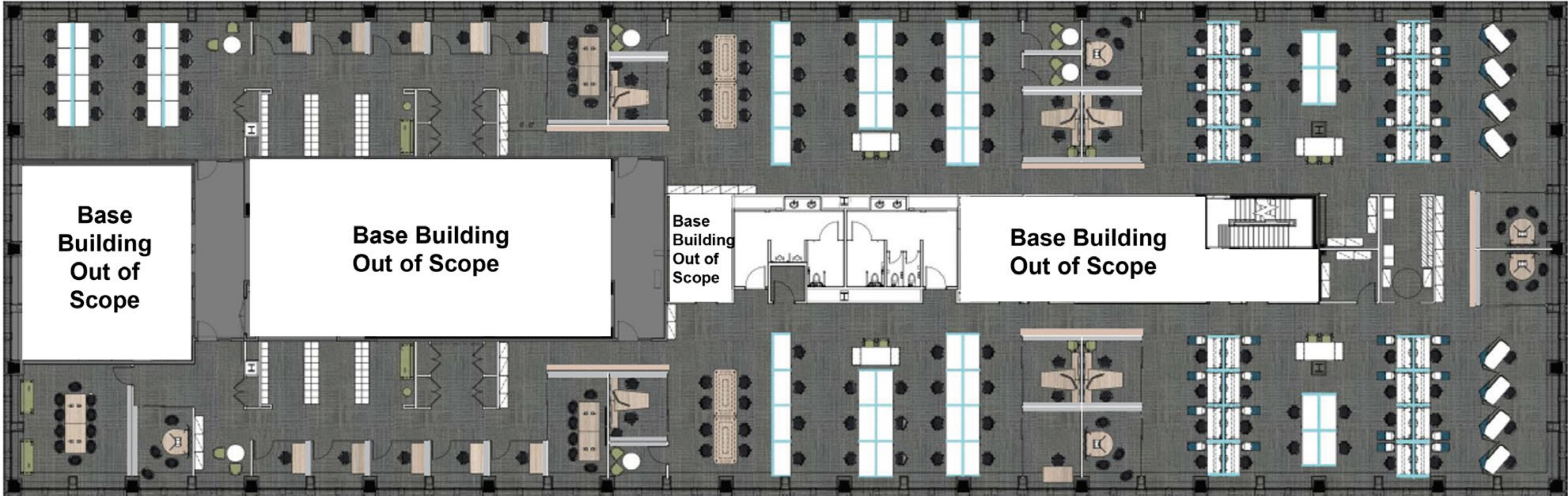

\*Note: Floorplan is for illustration purposes only.

**Legend**

- Upholstery Fabric Workstation Privacy Panel
- Upholstery Fabric Workstation Privacy Panel
- Upholstery Fabric
- White Laminate Work Surface
- Stretched Fabric Panel
- Wood Laminate Work Surface
- Laminate Wood Panel Architectural Wall

### 4.5.3 Iconic Nature Colour Application: Open and Enclosed Workspaces

Workstation Type A



Furniture Fabric Blue Range

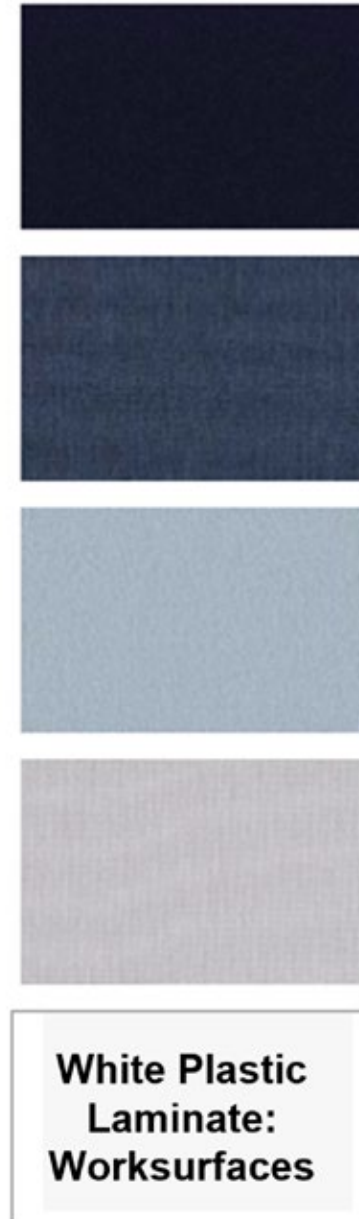

#### Open Workspaces

Shades of blue ranging from the pale blue of freshly fallen snow coating a field, to the deep blues from the depths of the great lakes are applied to the open offices area creating a calm and tranquil space for focus work.

Office / Small Meeting Room A

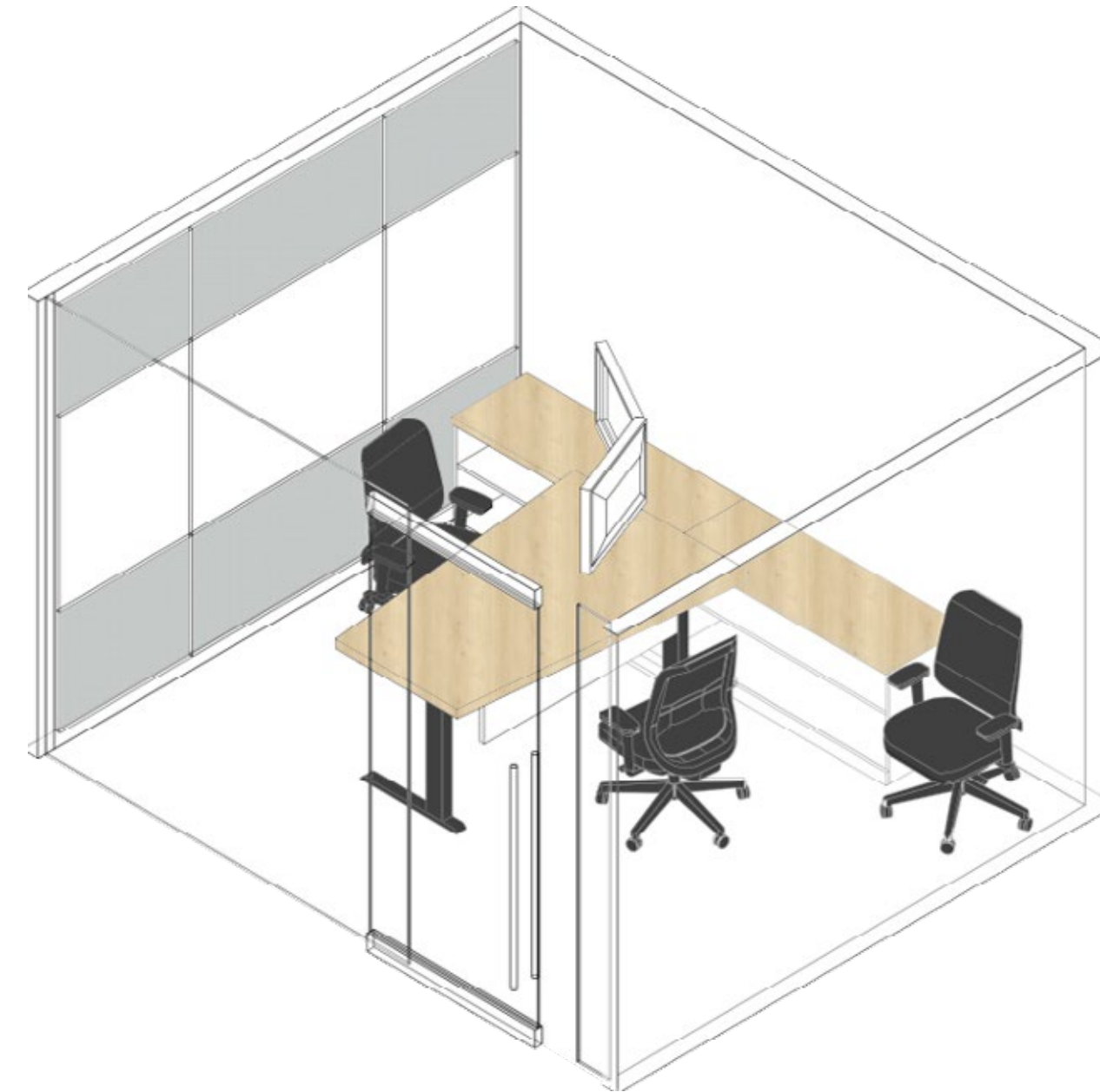

Stretch / Tackable Fabric



#### Enclosed Workspaces

Inspired by a crisp winter forest, light brown wood finishes compliment monochromatic fabrics in this space type.

### 4.5.4 Iconic Nature Colour Application: Open and Closed Alternative Workspaces

Like Ontario's expansive forests, Iconic Nature takes inspiration from the leafy greens and the natural wood to create engaging meeting rooms.

Open Collaboration A



60-Minute Room Type B2

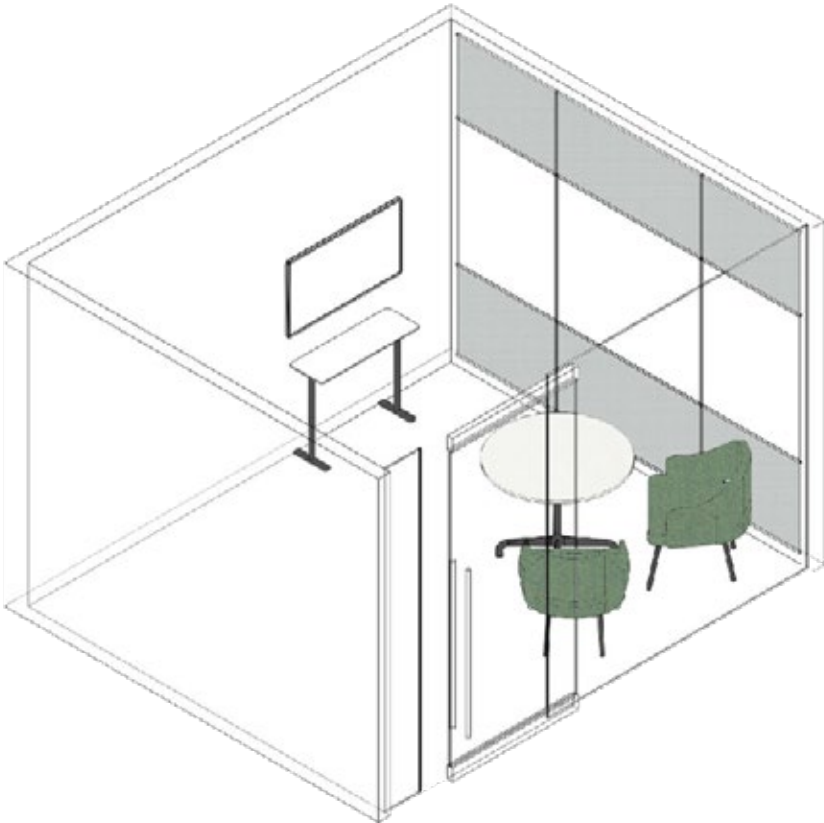

Open Collaboration C2

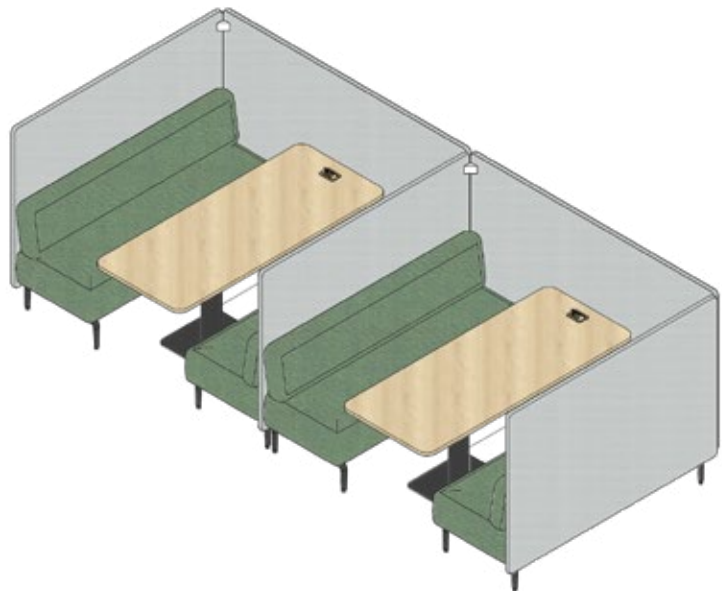

Medium Meeting Room C



**Wood Plastic Laminate:**  
meeting tables,  
surfaces and  
architectural walls



**White Plastic Laminate for Surfaces**

**Furniture Fabric  
Green Range**



**Stretch / Tackable Fabric**

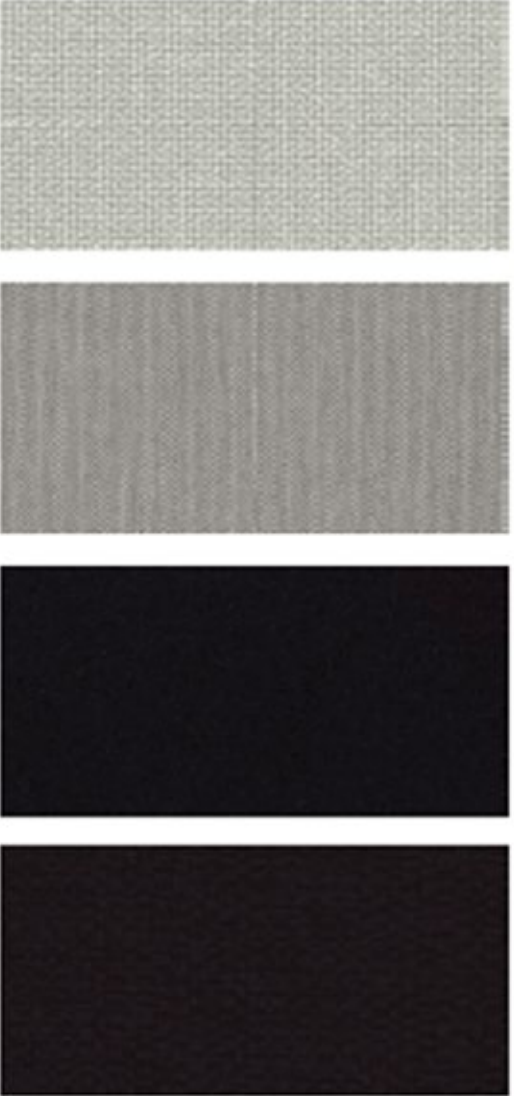



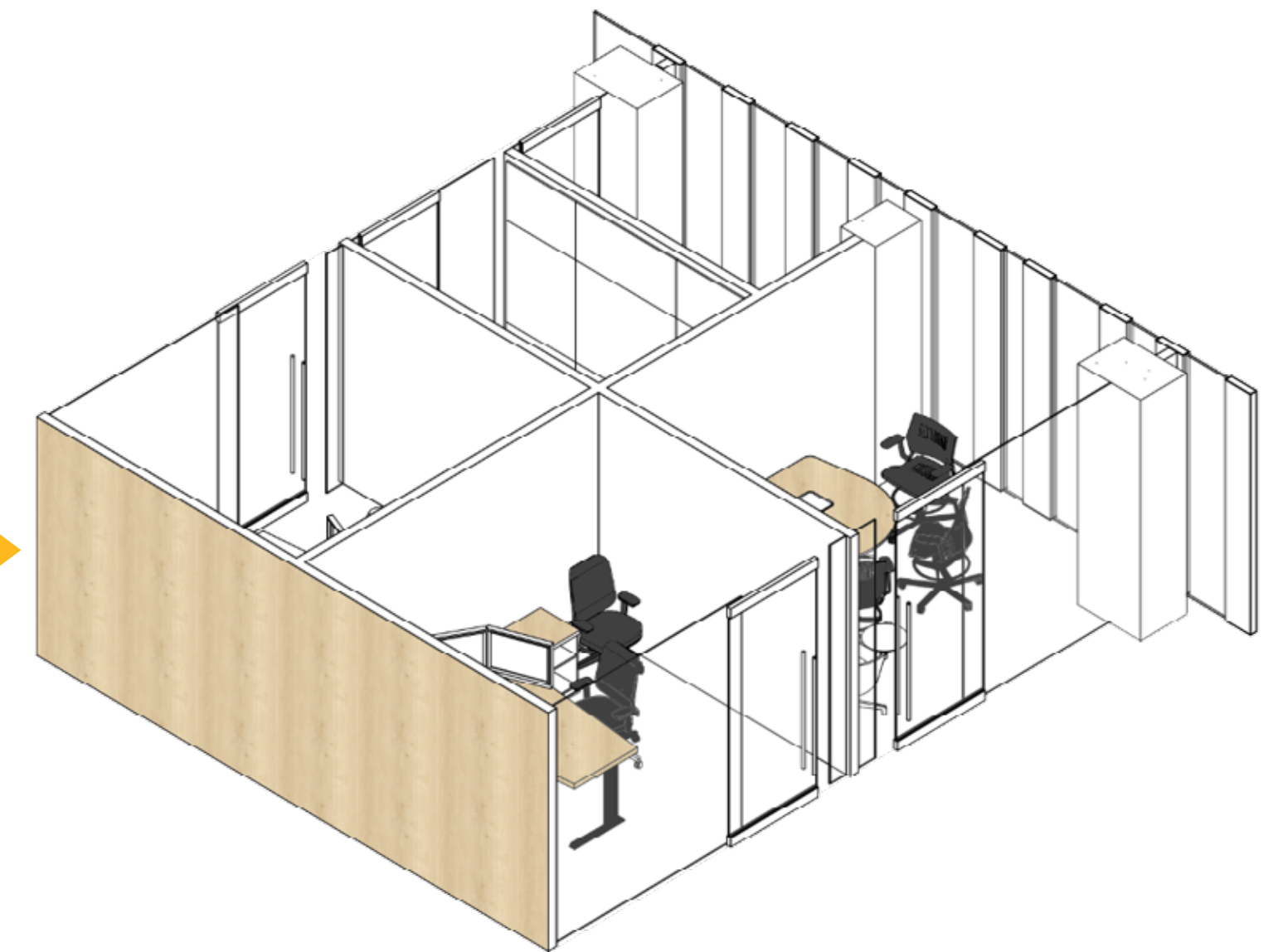
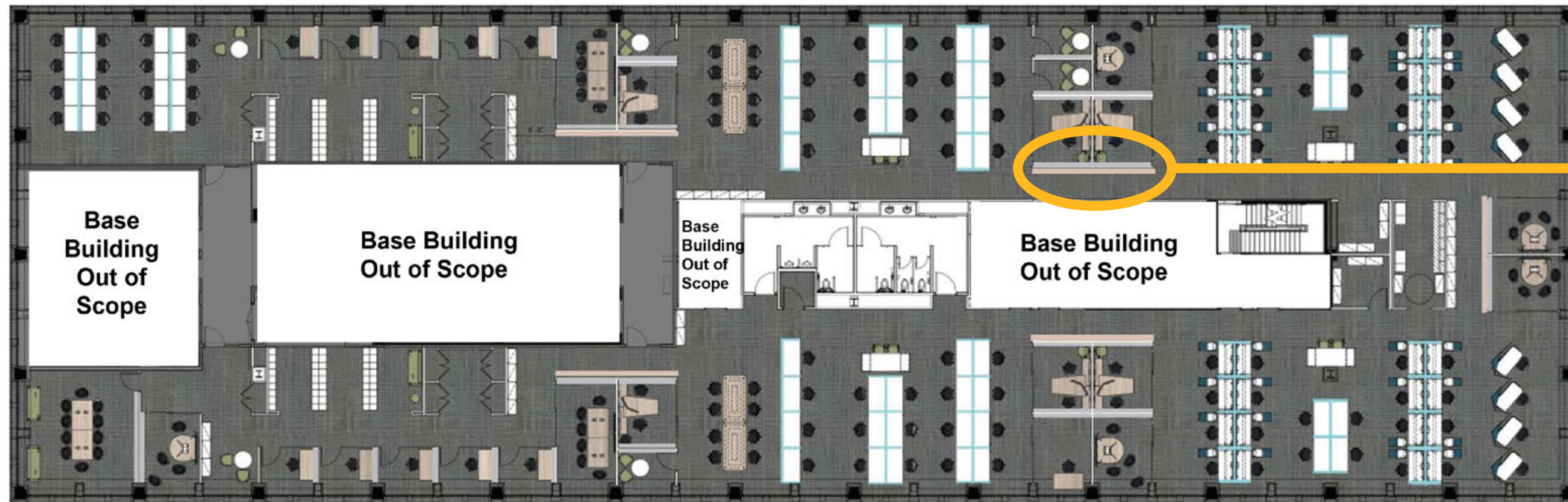



### 4.5.5 Wood Laminate Paneling Application



*Note: Floor plan is for illustration purposes only.*

*Isometric View of Wood Laminate Paneling Along Corridor*

#### Legend

- |                                                                                     |                                                    |                                                                                       |                                               |
|-------------------------------------------------------------------------------------|----------------------------------------------------|---------------------------------------------------------------------------------------|-----------------------------------------------|
|  | <i>Upholstery Fabric Workstation Privacy Panel</i> |  | <i>Stretched Fabric Panel</i>                 |
|  | <i>Upholstery Fabric Workstation Privacy Panel</i> |  | <i>Wood Laminate Work Surface</i>             |
|  | <i>Upholstery Fabric</i>                           |  | <i>Laminate Wood Panel Architectural Wall</i> |
|  | <i>White Laminate Work Surface</i>                 |                                                                                       |                                               |

## 4.6.0 WORKSPACES

Workspace Type	Size	Usable Square Feet	Comments
Workstation A	6'-0" x 2'-5"	Minimum 15 Maximum 36	6'-0" wide workstation. Convertible to Workstation B by adding a return.
Workstation B	6'-0" x 6'-0"	Maximum 36	6'-0" wide workstation. Convertible to Workstation A by removing the return.
Workstation C	4'-0" x 2'-6"	Minimum 15 Maximum 24	4'-0" wide height adjustable desk with no storage for shorter term focus work.
Workstation D	6'-0" x 4'-0"	Minimum 24 Maximum 36	6'-0" wide height adjustable desk with no storage privacy panels for increased focus.
Workstation E	4'-4" x 2'-6"	Minimum 15 Maximum 24	4'-4" wide height adjustable desk with wraparound privacy panels for increased focus. No storage at desk.
Office / Small Meeting Room A	10'-0" x 12'-0"	Maximum 120	1-person office with 2 guest chairs. By adjusting internal furniture, the room can provide three different options for use. Increased Access: adjustment to work surface orientation allows for a 2500 mm turning circle.

\* Measurements for all enclosed spaces are center of walls.

\*\* Please note that the furniture finishes in the following images are for illustrative purposes only and the final product may vary based on the furniture vendor selected.



Isometric View

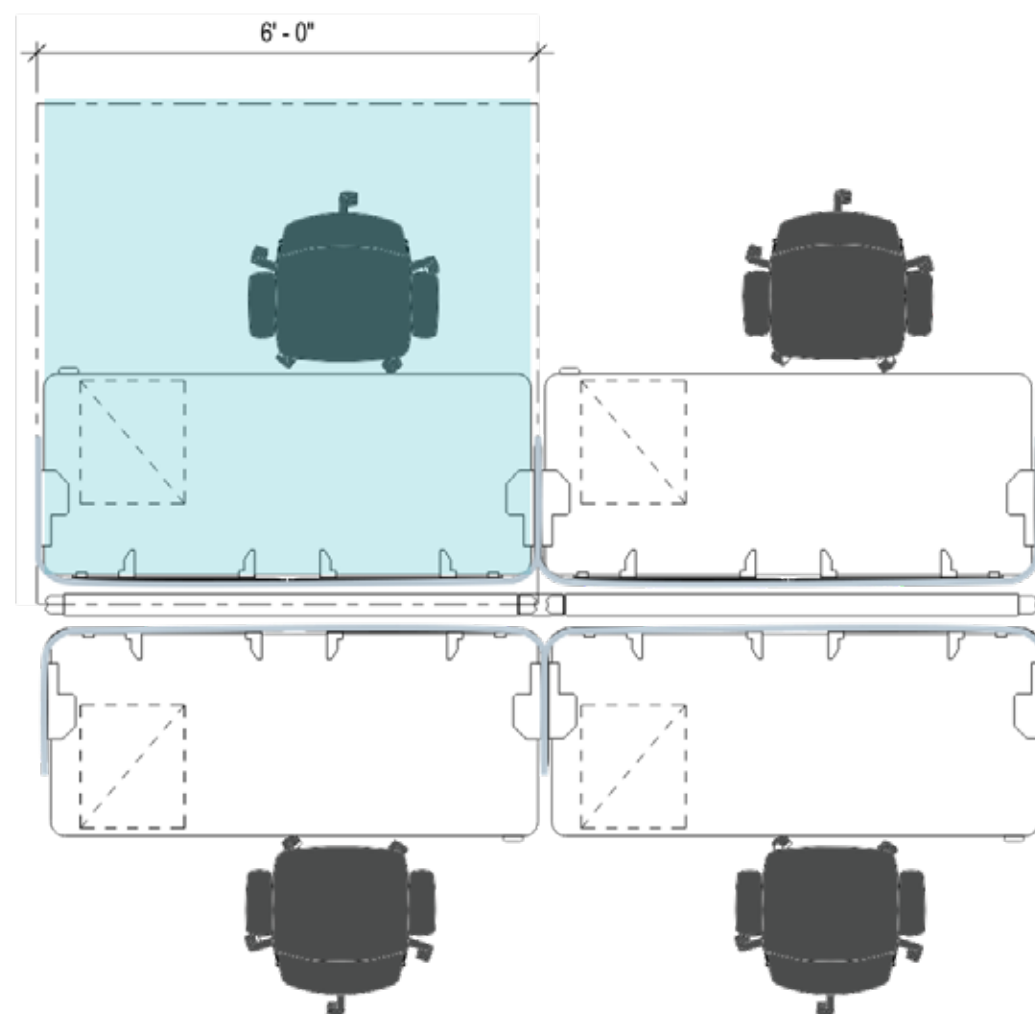

Standard Plan View of four Workstation A cluster  
Highlighted in blue is one Workstation A

#### 4.6.1 Workstation A

##### General Information

**Size:**  
Minimum 6'-0" x 2'-5" (15 USF)  
(Maximum 36 USF)

**Accessibility Requirements:**  
AODA / OBC compliant

**Architectural Requirements:**  
N/A

**Location:**  
Located along the perimeter for ample access to daylight

6'-0" wide workstation. Can be converted to Workstation B by adding a return.

##### Infrastructure

**At Work Surface:**

- » 3x Duplex power
- » 1x USB-C power

**Below Work Surface:**  
3x Duplex power

**IT/AV:**

- » Wi-fi throughout
- » Infrastructure and furniture to enable the GOVTechON digital workplace strategy. Please reference GO-ITS 80 and applicable KOP furniture requirements for technology

##### Furniture Requirements

- » Height adjustable desk (including modesty panel)
- » Cushion top mobile lockable box/file pedestal
- » Task chair
- » Seated privacy panel to be tackable
- » Dual monitor arms
- » Wire management for cables below surface
- » Ability to mount an articulating keyboard



Isometric View

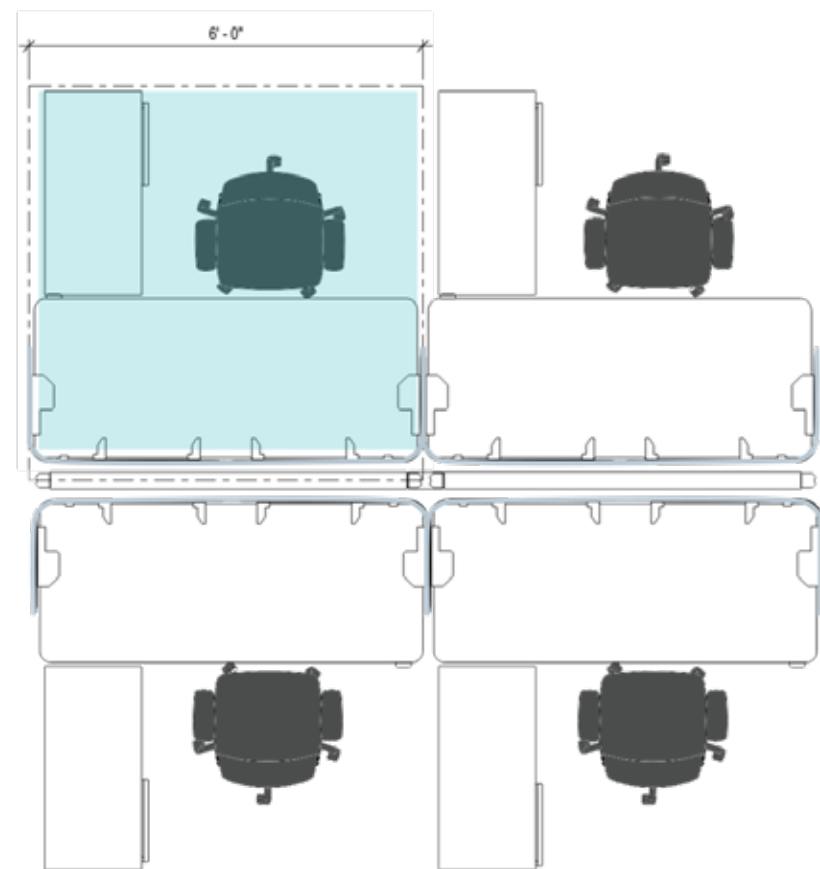

Standard Plan View of four Workstation B cluster  
Highlighted in blue is one Workstation B

## 4.6.2 Workstation B

### General Information

**Size:**  
Maximum 6'-0" x 6'-0" (36 USF)

**Accessibility Requirements:**  
AODA / OBC compliant

**Architectural Requirements:**  
N/A

**Location:**  
Located along the perimeter for ample access to daylight

6'-0" wide workstation. Can be converted to workstation A by removing return.

### Infrastructure

**At Work Surface:**

- » 3x Duplex power
- » 1x USB-C power

**Below Work Surface:**  
3x Duplex power

**IT/AV:**

- » Wi-fi throughout
- » Infrastructure and furniture to enable the GOVTechON digital workplace strategy. Please reference GO-ITS 80 and applicable KOP furniture requirements for technology

### Furniture Requirements

- » Height adjustable desk (including modesty panel)
- » Fixed height return
- » Cushion top mobile lockable box/file pedestal
- » Task chair
- » Seated privacy panel to be tackable
- » Dual monitor arms
- » Wire management for cables below surface
- » Ability to mount an articulating keyboard



Isometric View

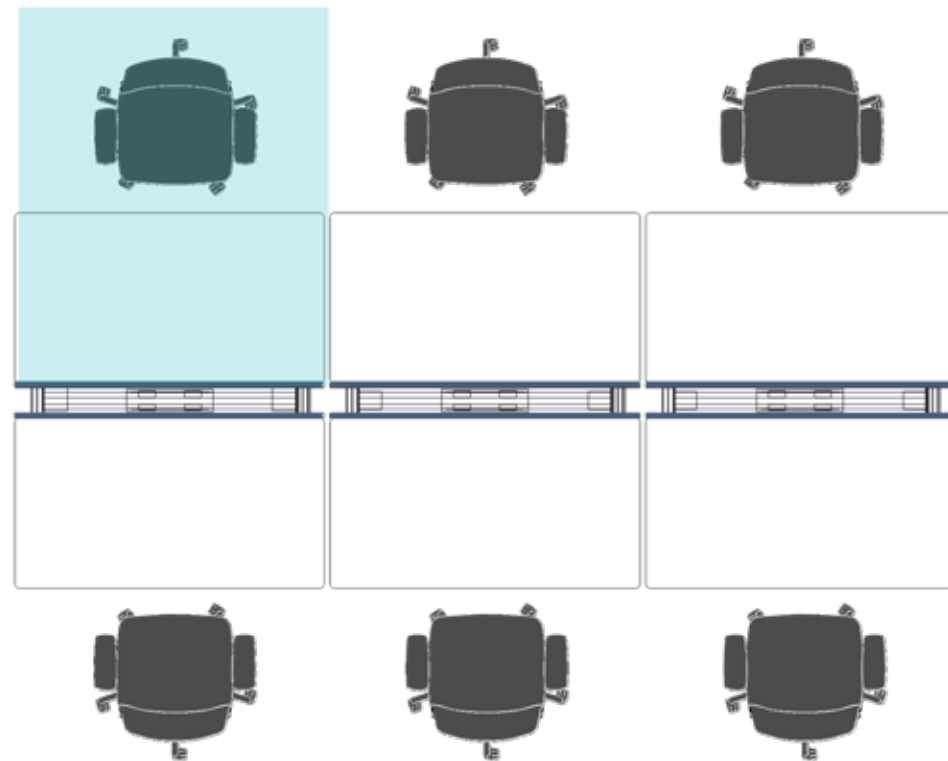

Standard Plan View of six Workstation C cluster  
Highlighted in blue is one Workstation C

### 4.6.3 Workstation C

#### General Information

**Size:**  
Minimum 4'-0" x 2'-6" (15 USF)  
(Maximum 24 USF)

**Accessibility Requirements:**  
AODA / OBC compliant

**Architectural Requirements:**  
N/A

**Location:**  
Open areas, adjacent to collaboration areas

4'-0" wide workstation for short-term focus work, no storage.

#### Infrastructure

**At Work Surface:**

- » 3x Duplex power
- » 1x USB-C power

**Below Work Surface:**  
3x Duplex power

**IT/AV:**

- » Wi-fi throughout
- » Infrastructure and furniture to enable the GOVTechON digital workplace strategy. Please reference GO-ITS 80 and applicable KOP furniture requirements for technology

#### Furniture Requirements

- » Height adjustable desk (including modesty panel)
- » Task chair
- » Wire management for cables below surface





Isometric View

#### 4.6.4 Workstation D

##### General Information

**Size:**  
Minimum 6'-0" x 4'-0" (24 USF)  
(Maximum 36 USF)

**Accessibility Requirements:**  
AODA / OBC compliant

**Architectural Requirements:**  
N/A

**Location:**  
Open areas, adjacent to other workstations

6'-0" wide workstation. Privacy panels for increased focus. No storage at desk.

##### Infrastructure

**At Work Surface:**

- » 3x Duplex power
- » 1x USB-C power

**Below Work Surface:**  
3x Duplex power

**IT/AV:**

- » Wi-fi throughout
- » Infrastructure and furniture to enable the GOVTechON digital workplace strategy. Please reference GO-ITS 80 and applicable KOP furniture requirements for technology

##### Furniture Requirements

- » Height adjustable desk (include modesty panel)
- » Task chair
- » High privacy screen
- » Dual monitor arms
- » Wire management for cables below surface
- » Ability to mount an articulating keyboard

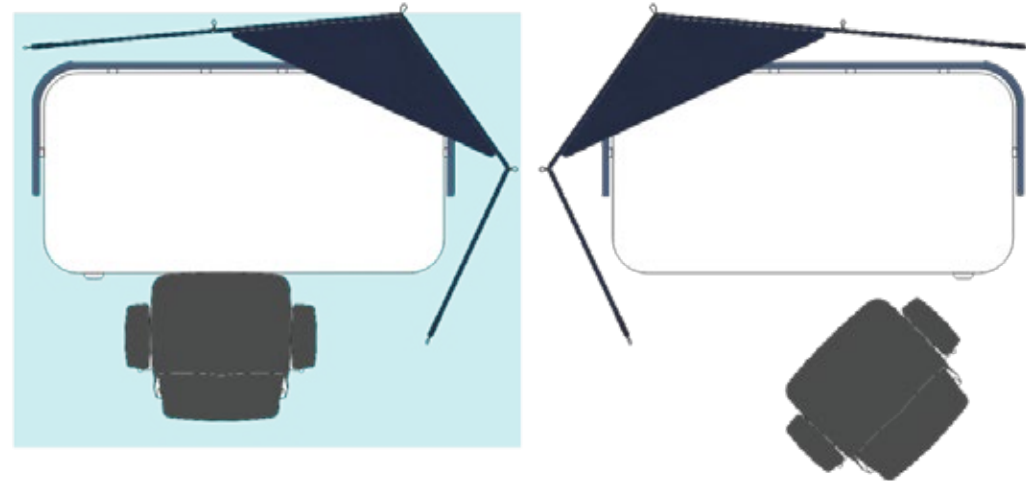

Standard Plan View of two Workstation D cluster  
Highlighted in blue is one Workstation D

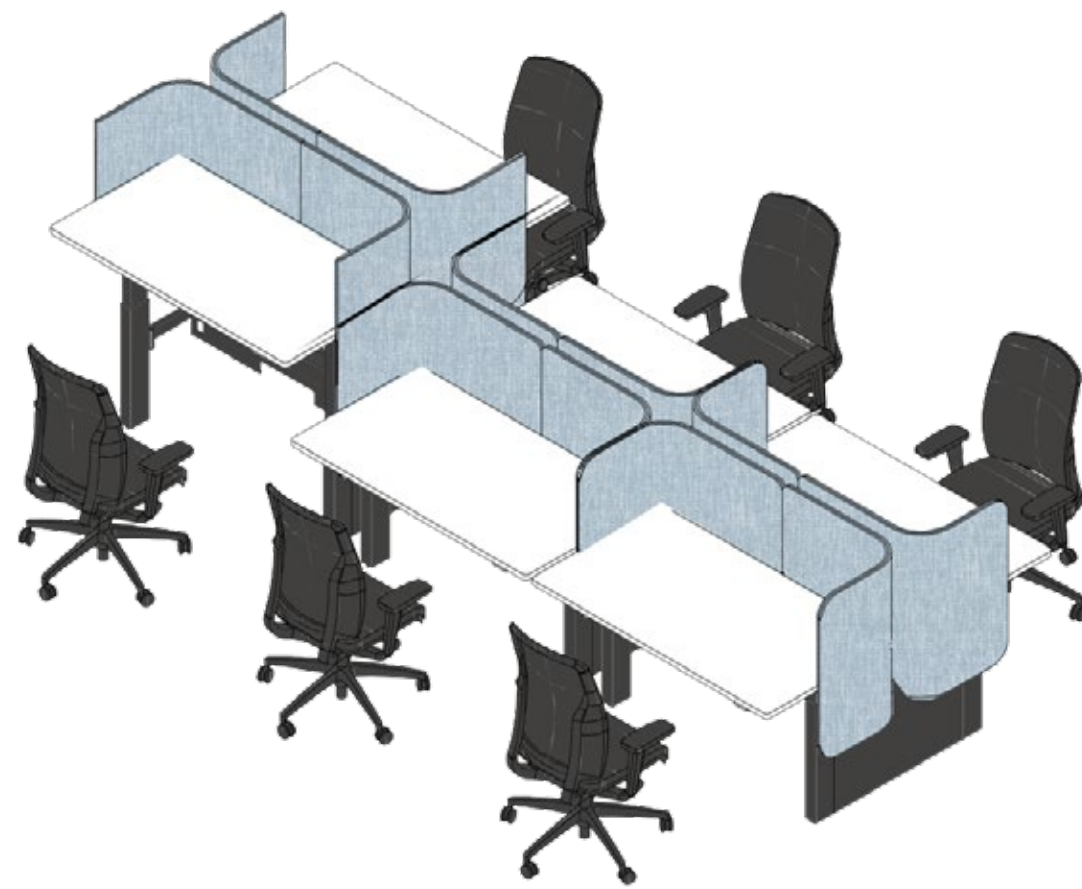

Isometric View

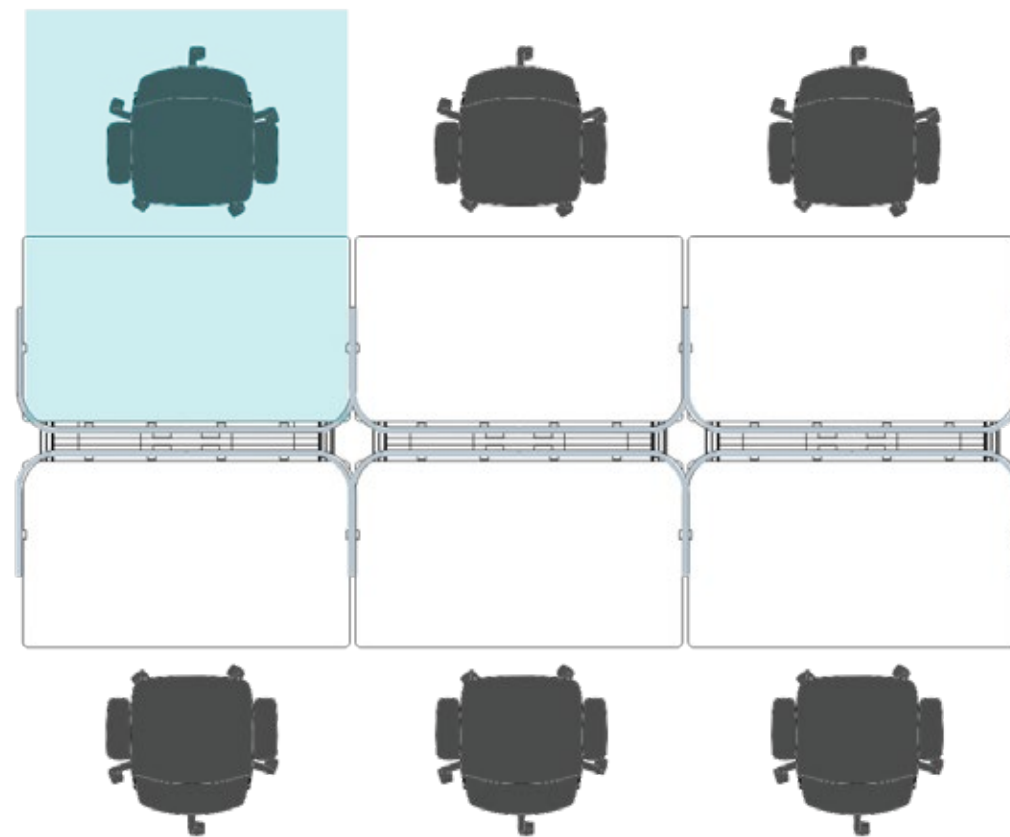

Standard Plan View of four Workstation E cluster  
Highlighted in blue is one Workstation E

#### 4.6.5 Workstation E

##### General Information

**Size:**  
Minimum 4'-4" x 2'-6" (15 USF)  
(Maximum 24 USF)

**Accessibility Requirements:**  
AODA / OBC compliant

**Architectural Requirements:**  
N/A

**Location:**  
Located along the perimeter for ample access to daylight

4'-4" wide workstation with wraparound privacy panels for increased focus. No storage at desk.

##### Infrastructure

**At Work Surface:**

- » 3x Duplex power
- » 1x USB-C power

**Below Work Surface:**  
3x Duplex power

**IT/AV:**

- » Wi-fi throughout
- » Infrastructure and furniture to enable the GOVTechON digital workplace strategy. Please reference GO-ITS 80 and applicable KOP furniture requirements for technology

##### Furniture Requirements

- » Height adjustable desk (including modesty panel)
- » Task chair
- » Seated privacy panel to be tackable
- » Dual monitor arms
- » Wire management for cables below surface
- » Ability to mount an articulating keyboard



Isometric view

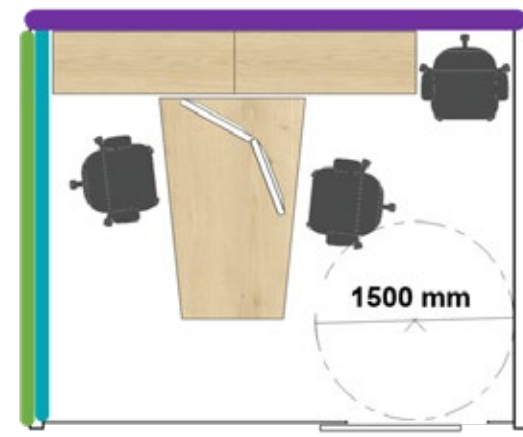

Standard Plan View



Isometric view

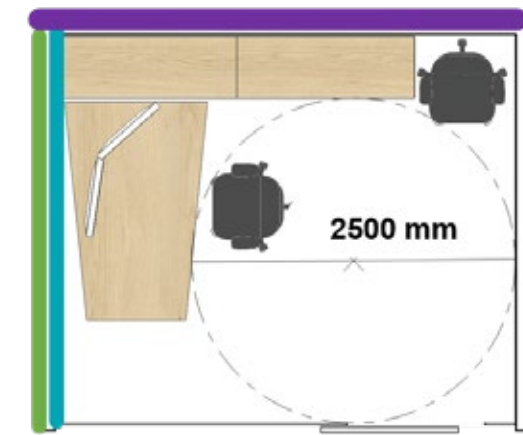

Increased Access Standard Plan View



Isometric view

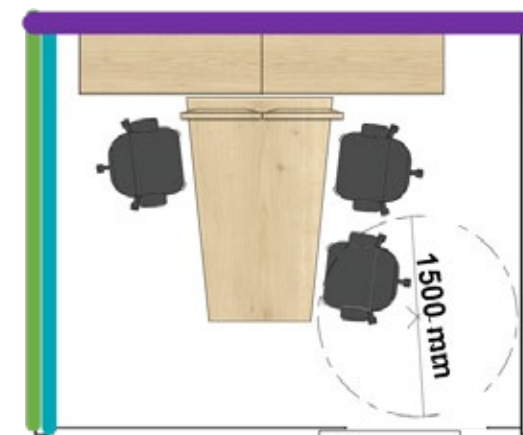

Small Meeting Room Standard Plan View

#### 4.6.6 Office / Small Meeting Room A

##### General Information

**Size:**  
Maximum 10'-0" x 12'-0" (120 USF)

**Occupancy:**  
1-4-person

**Accessibility Requirements:**

- » AODA / OBC compliant
- » Provide at least one seat with 900 mm clearance

**Architectural Requirements:**

- » Demountable Partitions:
  - » Full glass front with 36" wide privacy film and glass sliding door with 36" wide privacy film
  - » One (1) wall to have two (2) sections of writable surface and tackable acoustic panels for all other sections (with the option to mount artwork)
  - » Acoustical privacy baffling in ceiling
  - » Fire retardant 5/8-inch plywood blocking as required for wall-hung furniture and displays

*Notes: Glass front should be located on 12'-0" wall to ensure the increased access plan is achievable. If architectural fit can't be achieved, 10'-0" wall is acceptable.*

**Location:**  
Away from windows, adjacent to office/small meeting room

1-person office with 2 guest chairs. By adjusting internal furniture, the room can provide three different options for use.

##### Infrastructure

**At Work Surface:**

- » 3x Duplex power
- » 1x USB-C power
- » 1x AV
- » 1x Data

**Below Work Surface:**  
3x Duplex power

**Demountable Partition Door Frame:**  
Infrastructure (power/data) for future room booking hardware/system

**Per Wall Display:**

- » 2x Duplex power
- » 1x Data
- » 1x AV pathway from desk
- » 1x IPTV capability

**IT/AV:**

- » To be convertible to a small meeting/office
- » Prepare rough-ins to receive displays
- » Potential to mount a camera and/or collaboration bar above or below the display
- » Prepare rough-ins to receive room booking panel
- » Wi-fi throughout
- » Infrastructure and furniture to enable the GOVTechON digital workplace strategy. Please reference GO-ITS 80 and applicable KOP furniture requirements for technology

##### Furniture Requirements

- » Height adjustable desk with return (include modesty panel)
- » Task chair
- » Locking storage and open shelving below
- » 2x Guest chairs
- » Coat hook(s)
- » Dual monitor arms – the ability to swivel for meeting arrangement
- » Grommet hole in desk with cable management tray below surface
- » Ability to mount an articulating keyboard

*Notes: Height adjustable surface should be easily movable by user to achieve increased access as per plan view.*

- Tackable Acoustic Panels
- Writable Surface
- Primary infrastructure wall

## 4.7.0 ALTERNATIVE WORKSPACES (ENCLOSED)

Workspace Type	Size	Usable Square Feet	Comments
60-Minute Room A	6'-0" x 10'-0"	Maximum 60	Type A1 – Focus Type A2 - Collaborative Private space is provided for conference and video calls, as well as private conversations with acoustic control and fewer distractions.
60-Minute Room B Increased Access	12'-0" x 10'-0"	Maximum 120	Type B1 – Focus Type B2 - Collaborative Private space is provided for conference and video calls, as well as private conversations with acoustic control and fewer distractions, and additional space for a 2500 mm turning circle.
Small Meeting Room B	12'-0" x 10'-0"	Maximum 120	Can be converted to office A or small meeting room A with furniture change.
Medium Meeting Room A	10'-0" x 18'-0"	Maximum 180	6-person meeting room. Can be converted into one office and one 60-Minute Room with some construction work and additional furniture.
Medium Meeting Room B	15'-0" x 12'-0"	Maximum 180	6-person meeting room. Can be converted into one office/small meeting room A and one 60-Minute Room with some construction and furniture change.
Medium Meeting Room C	12'-0" x 20'-0"	Maximum 240	10-person meeting room. Can be converted into two Offices/Small Meeting room A or two small meeting room B with some construction and furniture change.

\* Measurements for all enclosed spaces are center of walls.

\*\* Please note that the furniture finishes in the following images are for illustrative purposes only and the final product may vary based on the furniture vendor selected.

### 4.7.1 60-Minute Rooms A and B Overview

Private space provided for conference and video calls, as well as private conversations with acoustic control and fewer distractions.

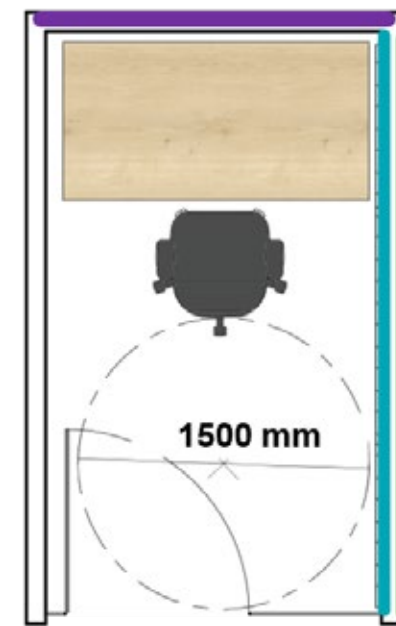

**Type A1 – Focus**

Space for one person for dedicated focus or acoustic privacy

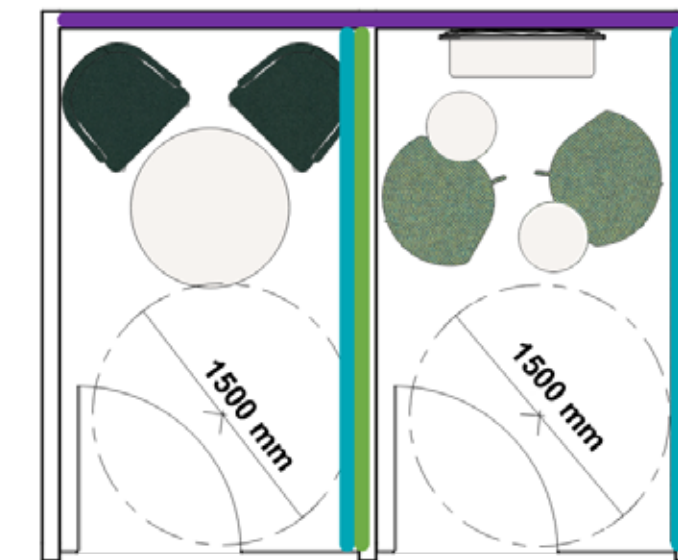
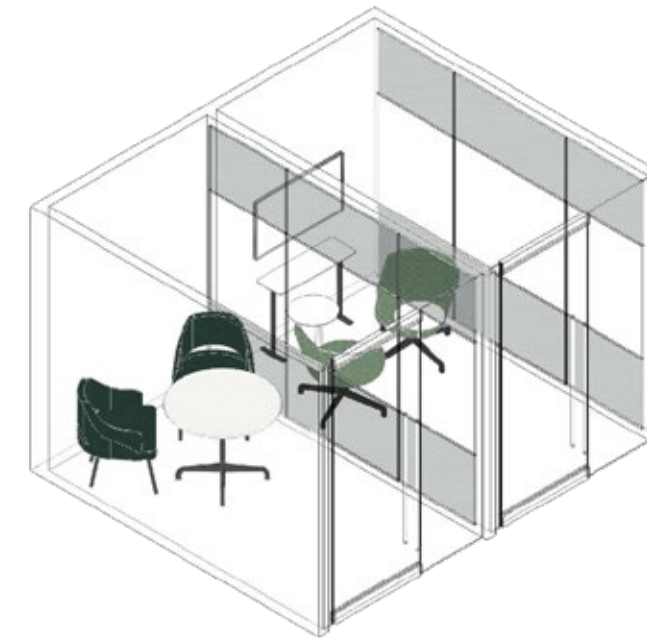

**Type A2 - Collaborative**

One on one space for collaboration or acoustic privacy

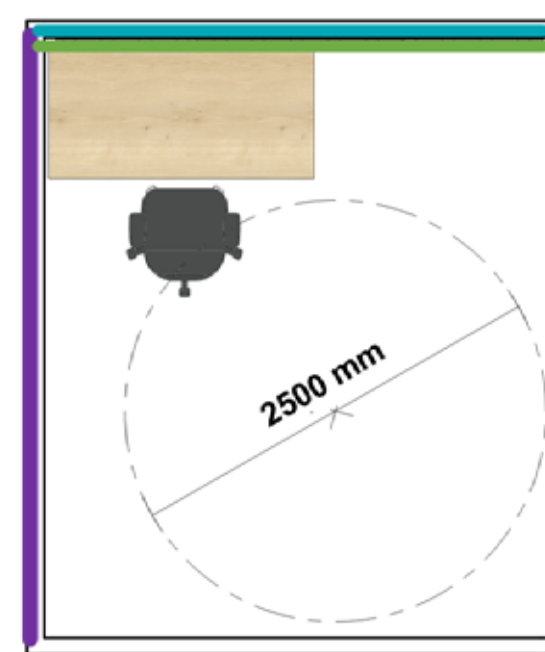
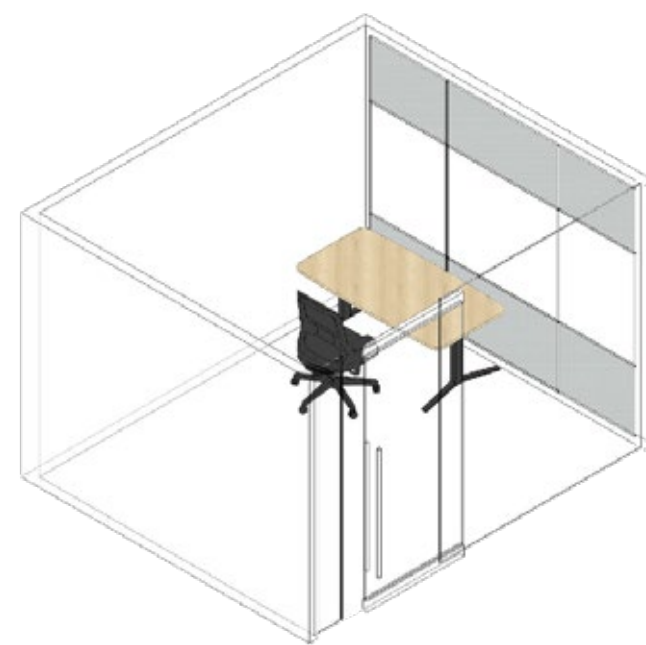

**Type B1 – Focus Increased Access**

A larger footprint allows for a 2500 mm turning circle with sliding door

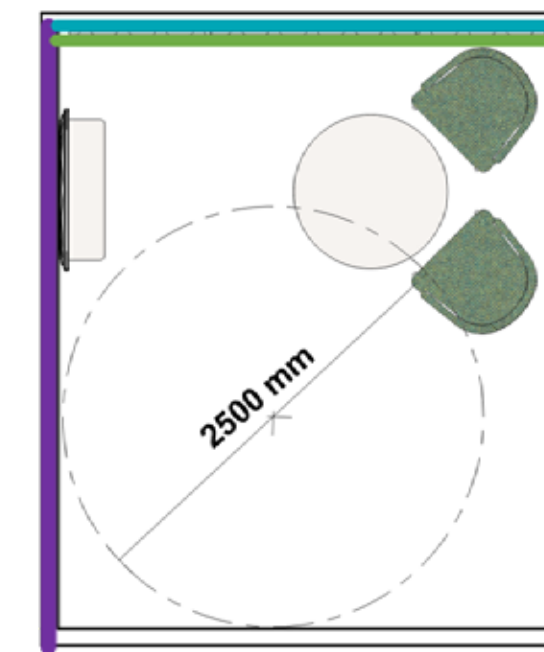
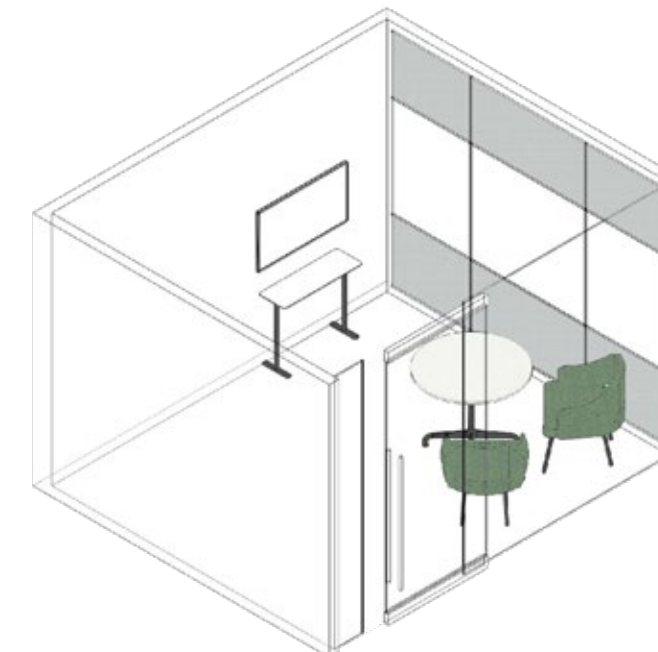

**Type B2 – Collaborative Increased Access**



A larger footprint allows for a 2500 mm turning circle with sliding door

- Tackable Acoustic Panels
- Writable Surface
- Primary infrastructure wall

### Privacy Film

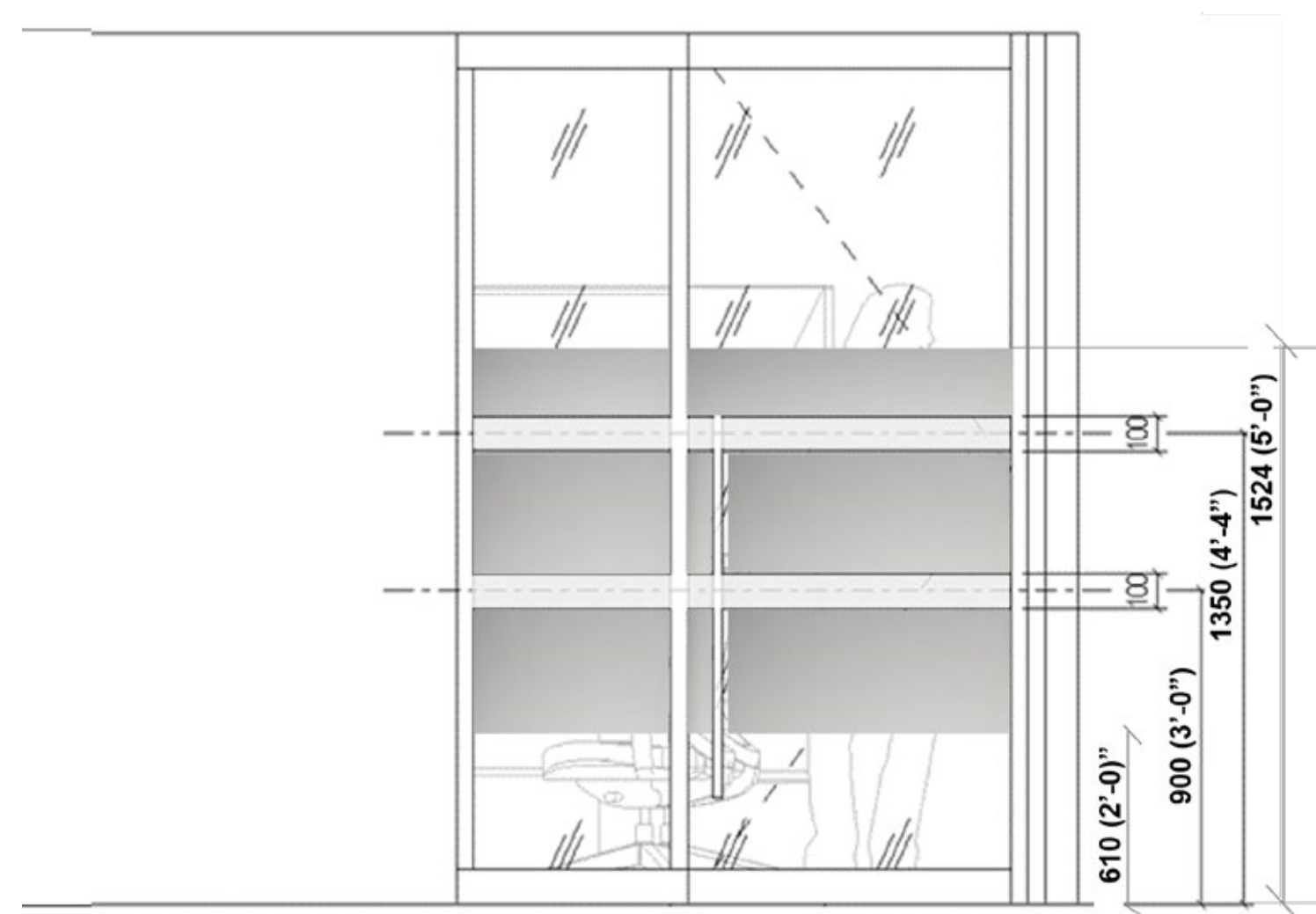
Distraction bands are a code mandated strip of film on all glass partitions, to enhance visibility. Privacy film can be used to enhance the space through branding and wayfinding, above this code-mandated minimum.

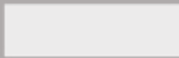

-  Distraction bands (minimum requirement): Two (2) white matte/opaque 100 mm strips. First strip is located at 1350 mm, 100 mm strip located between 850-1000 mm
-  Privacy film to begin from 610 mm above finished floor (AFF) and finish at 1524 AFF. Dusted Crystal or similar translucent film 36" band size.

### Signage Mounting

Typical sign mounting to be coordinated with signage standards package. Where glass door and sidelight exist, sign to be glass mounted, with vinyl second surface backing.

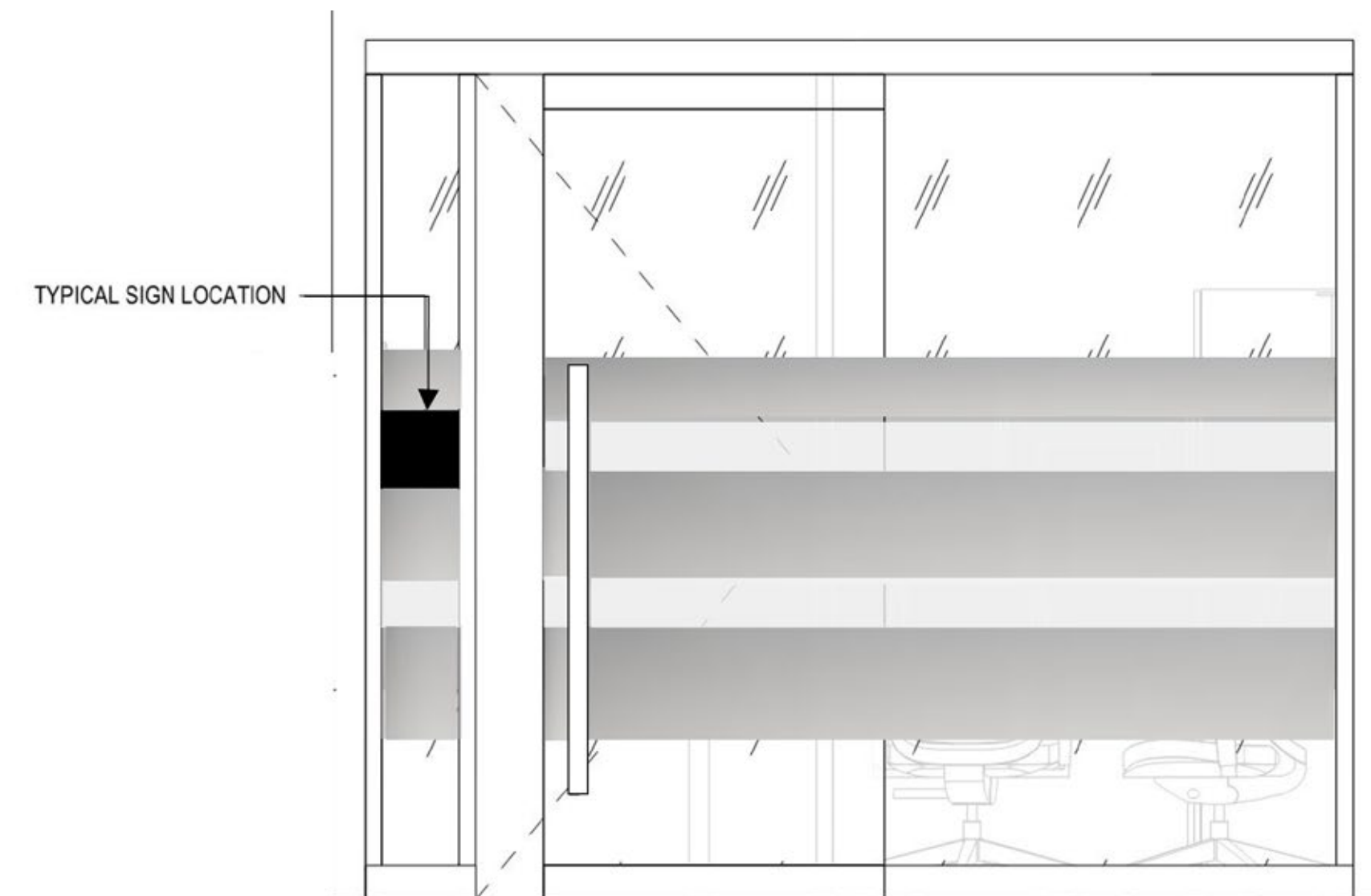

Bottom of sign to be mounted at 1200 mm above finished floor and 100 mm from the edge of the door frame.



Isometric View of A1 60-Minute Room

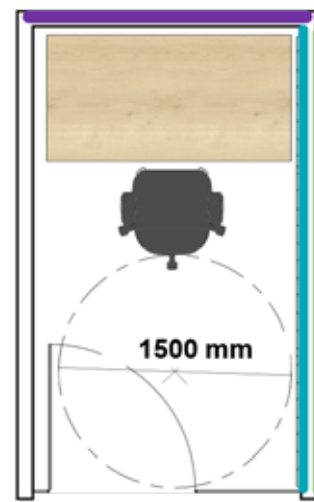

Standard Plan View of A1 60-Minute Room

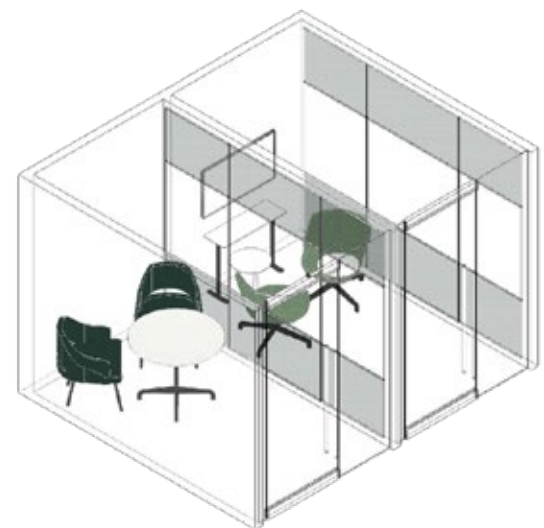

Isometric View of two A2 60-Minute Rooms



Standard Plan View of two A2 60-Minute Rooms

- Tackable Acoustic Panels
- Writable Surface
- Primary infrastructure wall

## 4.7.2 60-Minute Rooms Type A

### General Information

#### Size:

Maximum 6'-0" x 10'-0" (60 USF)  
*Calculated from the center of the walls*

#### Occupancy:

1-2-person

#### Accessibility Requirements:

- » AODA / OBC compliant
- » Provide at least one seat with 900 mm clearance

#### Architectural Requirements:

- » Demountable Partitions
  - » Full glass front with 36" wide privacy film and glass swing door with 36" wide privacy film
  - » One (1) wall to have two (2) sections of writable surface and tackable acoustic panels for all other sections (with the option to mount artwork)
  - » Acoustical privacy baffling in ceiling
  - » Fire retardant 5/8-inch plywood blocking as required for wall-hung furniture and displays

#### Location:

Throughout the space

Type A1 - Focus

Type A2 - Collaborative

Private space provided for conference and video calls, as well as private conversations with acoustic control and fewer distractions.

### Infrastructure

#### At Work Surface / Accessible Height:

- » 1x Duplex power
- » 1x USB-C power
- » 1x Data

#### Per Wall Display (for future wall display if applicable):

- » 2x Duplex power
- » 1x AV
- » 1x Data
- » 1x IPTV capability

#### IT/AV:

- » Potential to mount a camera and/or collaboration bar above or below the display
- » Prepare rough-ins to receive displays at the furniture/back wall
- » Wi-fi throughout
- » Infrastructure and furniture to enable the GOVTechON digital workplace strategy. Please reference GO-ITS 80 and applicable KOP furniture requirements for technology

### Furniture Requirements

#### Varies:

- » Height adjustable work surface (Type A1)
- » Task chair (Type A1)
- » Ancillary seating (Type A2)
- » Ancillary work height tables (Type A2)
- » Tablet armchair (Type A2)
- » Laptop table (Type A2)
- » Cable management tray below surface (Type A1)

*Notes: There are two types of 60-minute rooms. Type A1 is used for focus (table and chair). Type A2 is used more for collaboration (two chairs and a table). Type A1 should have ~60% and Type A2 should consist of ~40% within the floor plan. Type A1 can be used as a workspace when required.*

### 4.7.3 60-Minute Rooms Type B Increased Access

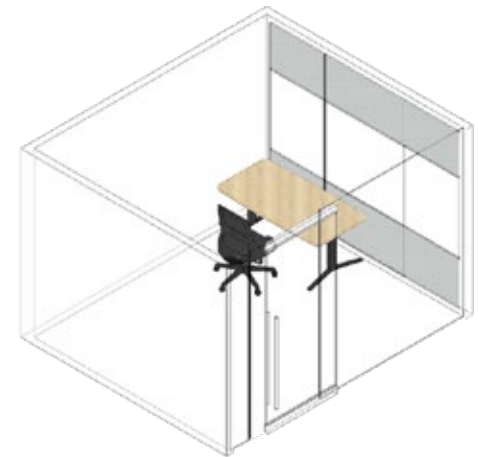

Isometric View of B1 60-Minute Room

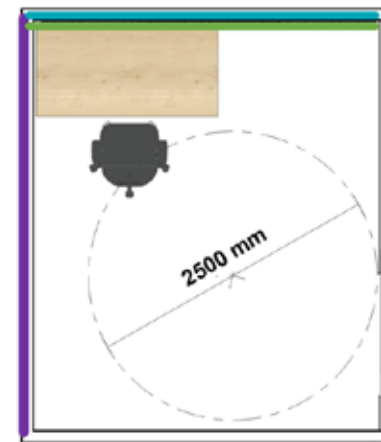

Standard Plan View of B1 60-Minute Room

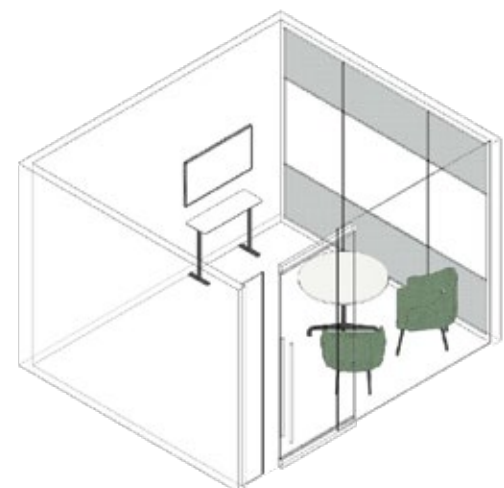

Isometric View of B2 60-Minute Room

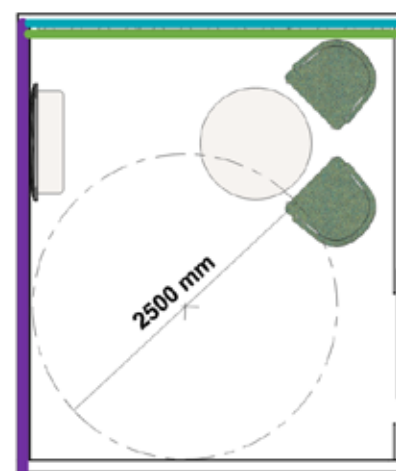

Standard Plan View of B2 60-Minute Room

- Tackable Acoustic Panels
- Writable Surface
- Primary infrastructure wall

#### General Information

##### Size:

Maximum 12'-0" x 10'-0" (120 USF) for 2500 mm circle (Increased Access)

Calculated from the center of the walls

##### Occupancy:

2-person

##### Accessibility Requirements:

- » AODA / OBC compliant
- » Provide a clear 2500 mm turning circle

##### Architectural Requirements:

- » Demountable Partitions:
  - » Full glass front with 36" wide privacy film and glass sliding door with 36" wide privacy film
  - » One (1) wall to have two (2) sections of writable surface and tackable acoustic panels for all other sections (with the option to mount artwork)
  - » Acoustical privacy baffling in ceiling
  - » Fire retardant 5/8-inch plywood blocking as required for wall-hung furniture and displays

##### Location:

Throughout the space

Type B1 – Focus

Type B2 - Collaborative

Private space provided for conference and video calls, as well as private conversations with acoustic control and fewer distractions.

#### Infrastructure

##### At Surface / accessible height:

- » 1x Duplex power
- » 1x USB-C power
- » 1x Data

##### Per Wall Display (for future wall display if applicable):

- » 2x Duplex power
- » 1x AV
- » 1x Data
- » 1x IPTV capability

##### IT/AV:

- » Potential to mount a camera and/or collaboration bar above or below the display
- » Prepare rough-ins to receive displays at the wall opposite the door
- » Wi-fi throughout
- » Infrastructure and furniture to enable the GOVTechON digital workplace strategy. Please reference GO-ITS 80 and applicable KOP furniture requirements for technology

#### Furniture Requirements

##### Varies:

- » Height adjustable work surface (Type B1)
- » Task chair (Type B1)
- » Ancillary seating (Type B2)
- » Ancillary work height tables (Type B2)
- » Tablet armchair (Type B2)
- » Laptop table (Type B2)
- » Cable management tray below surface (Type B1)

Notes: There are two types of 60-minute rooms. Type B1 is used for focus work (table and chair) with increased access. Type B2 is used for collaboration (two chairs and a table) with increased access. Type B1 should have 60% and Type B2 should consist of 40% within the floor plan.





Isometric View

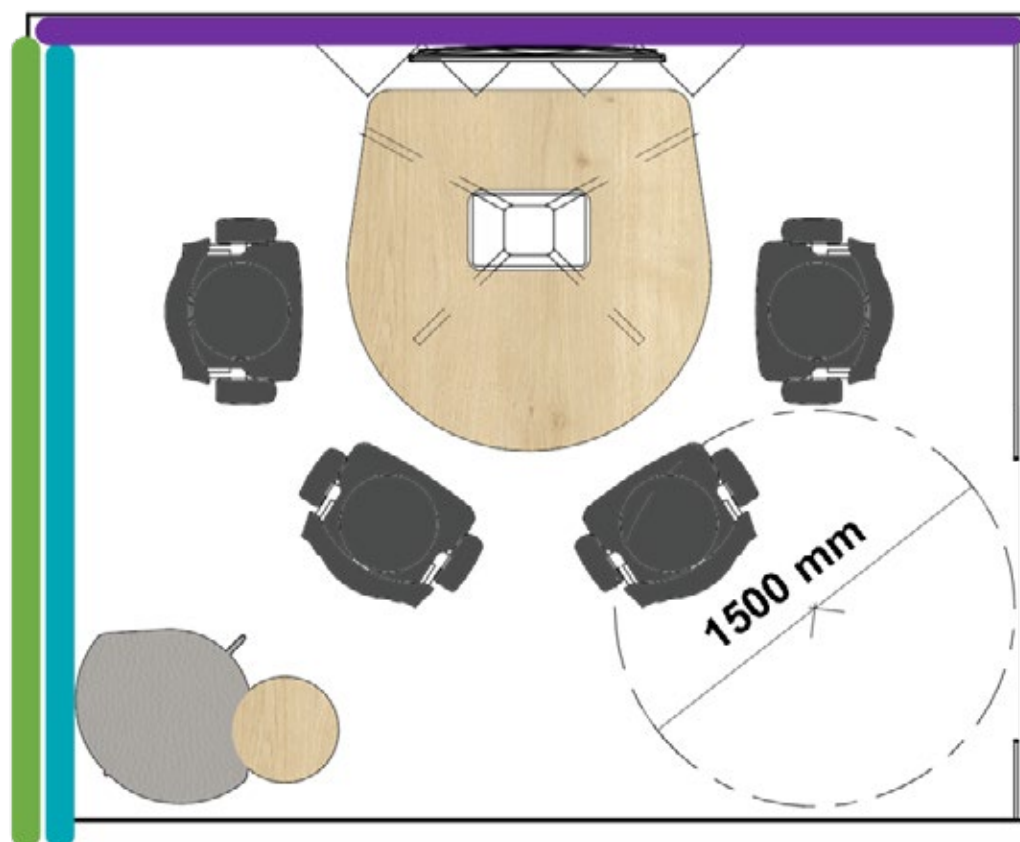

Standard Plan View

- Tackable Acoustic Panels
- Writable Surface
- Primary infrastructure wall

#### 4.7.4 Small Meeting Room B

##### General Information

**Size:**  
Maximum 10'-0" x 12'-0" (120 USF)  
*Calculated from the center of the walls*

**Occupancy:**  
4-person

##### Accessibility Requirements:

- » AODA / OBC compliant
- » Provide at least one seat with 900 mm clearance

##### Architectural Requirements:

- » Demountable Partitions:
  - » Full glass front with 36" wide privacy film and glass sliding door with 36" wide privacy film
  - » One (1) wall to have two (2) sections of writable surface and tackable acoustic panels for all other sections (with the option to mount artwork)
  - » Acoustical privacy baffling in ceiling
  - » Fire retardant 5/8-inch plywood blocking as required for wall-hung furniture and displays

##### Location:

Away from windows

4-person meeting room. Can be converted to Meeting room A or an office with furniture changes.

##### Infrastructure

###### At Surface:

- » 3x Duplex power
- » 1x USB-C power
- » 1x Data
- » 1x AV (flip top)

###### Below Worksurface:

3x Duplex power

###### Per Wall Display:

- » 2x Duplex power
- » 1x AV
- » 1x Data
- » 1x IPTV capability
- » 1x AV pathway from surface

###### Demountable Partition Door Frame:

Infrastructure (power/data) for future room booking hardware/system

###### IT/AV:

- » Potential to mount a camera and/or collaboration bar above or below the display
- » Prepare rough-ins to receive displays
- » Prepare rough-ins to receive room booking panel
- » To be convertible to an office
- » Wi-fi throughout
- » Infrastructure and furniture to enable the GOVTechON digital workplace strategy. Please reference GO-ITS 80 and applicable KOP furniture requirements for technology

##### Furniture Requirements

- » Height adjustable D-shape surface
- » 4x Stool task chairs
- » Electrical grommet with cable management tray below surface
- » Coat hook(s)
- » Tablet armchair (optional)

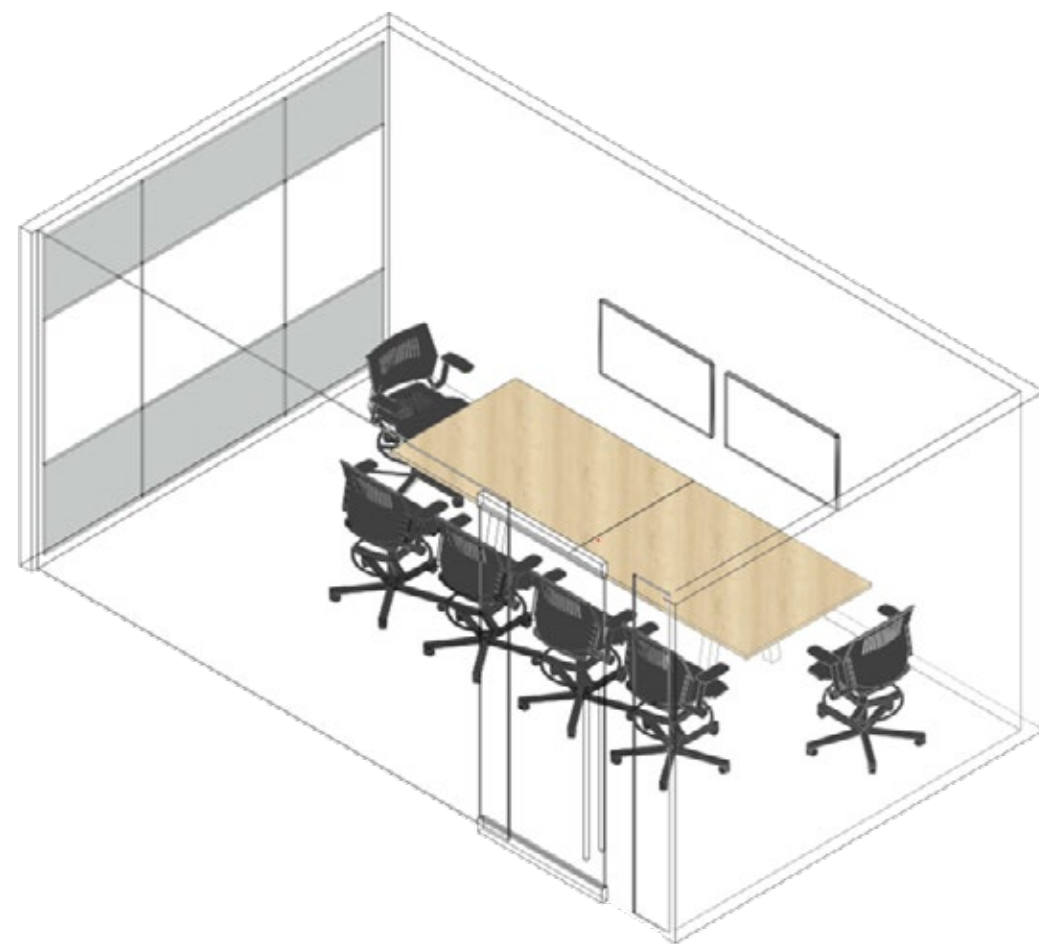

Isometric View

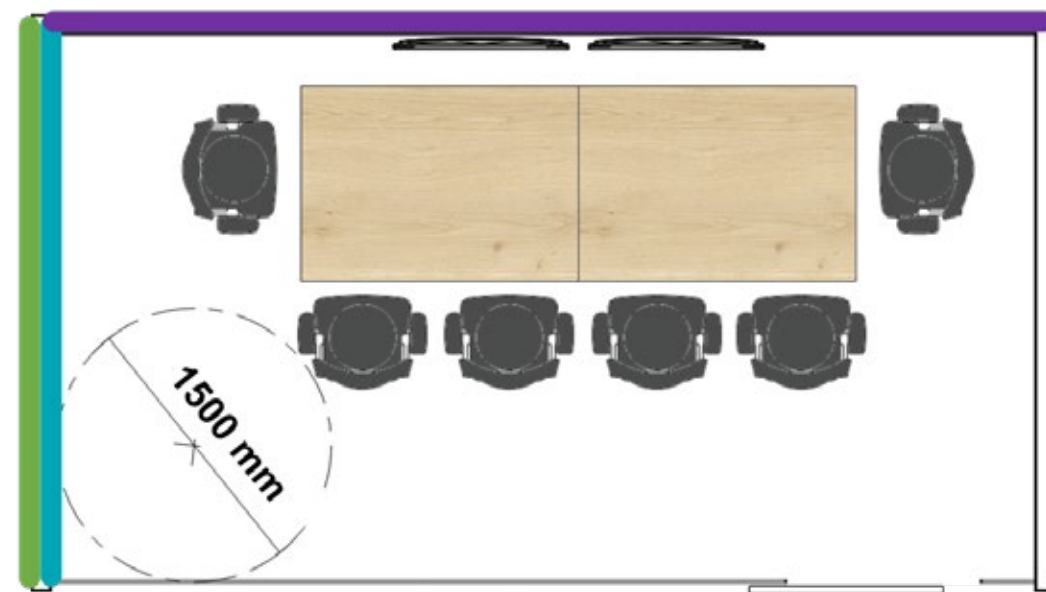

Standard Plan View

- Tackable Acoustic Panels
- Writable Surface
- Primary infrastructure wall

#### 4.7.5 Medium Meeting Room A

##### General Information

**Size:**  
Maximum 10'-0" x 18'-0" (180 USF)  
Calculated from the center of the walls

**Occupancy:**  
6-person

##### Accessibility Requirements:

- » AODA / OBC compliant
- » Provide at least one seat with 900 mm clearance

##### Architectural Requirements:

- » Demountable Partitions:
  - » Full glass front with 36" wide privacy film and glass sliding door with 36" wide privacy film
  - » One (1) wall to have two (2) sections of writable surface and tackable acoustic panels for all other sections (with the option to mount artwork)
  - » Acoustical privacy baffling in ceiling
  - » Fire retardant 5/8-inch plywood blocking as required for wall-hung furniture and displays

##### Location:

At core, distributed

6-person meeting room. Can be converted into one office and one 60-minute room with some construction work and furniture changes.

##### Infrastructure

###### At Surface:

- 2x Table monuments each with:
- » 2x Duplex power
  - » 2x USB-C power
  - » 1x Data
  - » 1x AV

###### Per Wall Display:

- » 2x Duplex power
- » 1x AV
- » 1x Data
- » 1x IPTV capability
- » 1x AV pathway from surface

###### Demountable Partition Door Frame:

Infrastructure (power/data) for future room booking hardware/system

###### IT/AV:

- » Prepare rough-ins to receive displays
- » Potential to mount a camera and/or collaboration bar above or below the display
- » Provide option for dual displays where space allows
- » Prepare rough-ins to receive room booking panel
- » Wi-fi throughout
- » Infrastructure and furniture to enable the GOVTechON digital workplace strategy. Please reference GO-ITS 80 and applicable KOP furniture requirements for technology

##### Furniture Requirements

- » Meeting table on lockable castors
- » Electrical grommet with cable management tray below surface
- » 6x Meeting chairs



Isometric View

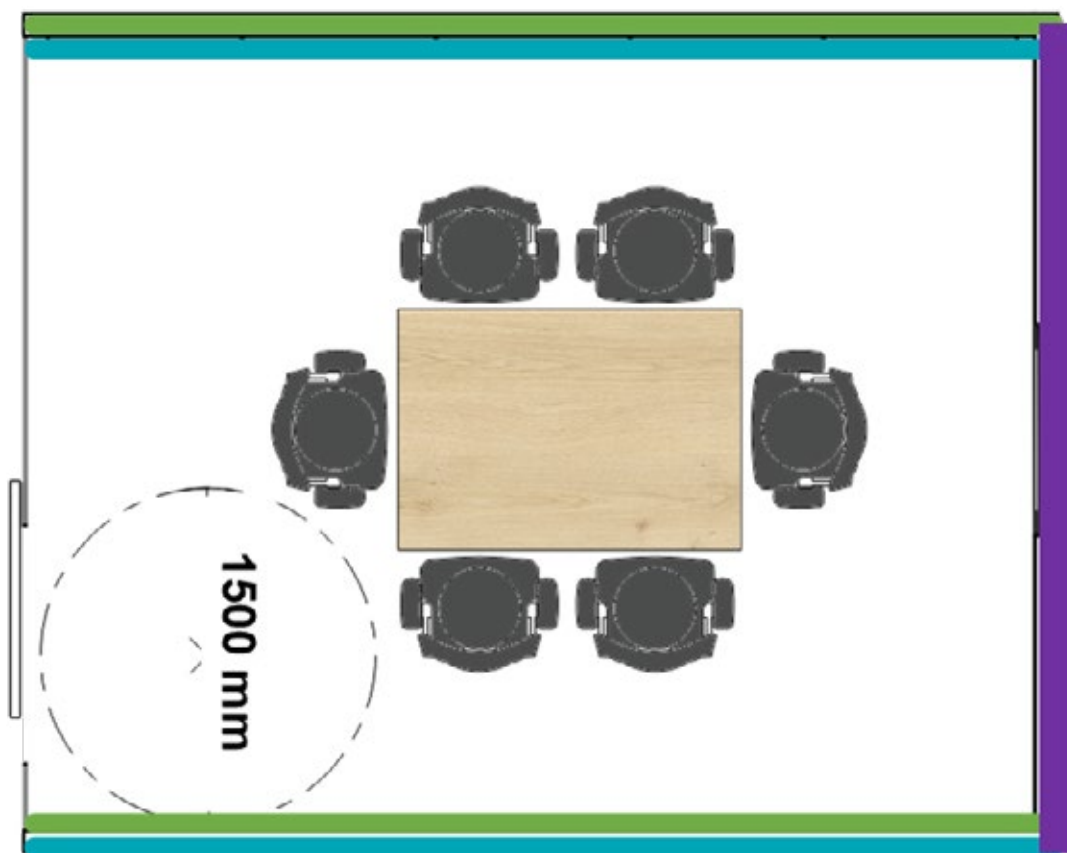

Standard Plan View

- Tackable Acoustic Panels
- Writable Surface
- Primary infrastructure wall

#### 4.7.6 Medium Meeting B

##### General Information

**Size:**  
Maximum 15'-0" x 12'-0" (180 USF)  
*Calculated from the center of the walls*

**Occupancy:**  
6-person

##### Accessibility Requirements:

- » AODA / OBC compliant
- » Provide at least one seat with 900 mm clearance

##### Architectural Requirements:

- » Demountable Partitions:
  - » Full glass front with 36" wide privacy film and glass sliding door with 36" wide privacy film
  - » One (1) wall to have two (2) sections of writable surface and tackable acoustic panels for all other sections (with the option to mount artwork)
  - » Acoustical privacy baffling in ceiling
  - » Fire retardant 5/8-inch plywood blocking as required for wall-hung furniture and displays

##### Location:

At core, distributed

6-person meeting room. Can be converted into one office/small meeting room A and one 60-minute room with some construction and furniture changes.

##### Infrastructure

###### At Surface:

- 2x Table monuments each with:
- » 2x Duplex power
  - » 2x USB-C power
  - » 1x AV
  - » 1x Data

###### Per Wall Display:

- » 2x Duplex power
- » 1x AV
- » 1x Data
- » 1x IPTV capability
- » 1x AV pathway from surface

###### Demountable Partition Door Frame:

Infrastructure (power/data) for future room booking hardware/system

###### IT/AV:

- » Prepare rough-ins to receive displays
- » Potential to mount a camera and/or collaboration bar above or below the display
- » Provide option for dual displays where space allows
- » Prepare rough-ins to receive room booking panel
- » Wi-fi throughout
- » Infrastructure and furniture to enable the GOVTechON digital workplace strategy. Please reference GO-ITS 80 and applicable KOP furniture requirements for technology

##### Furniture Requirements

- » Meeting table
- » Electrical grommet with cable management tray below surface
- » 6x Meeting chairs



Isometric View

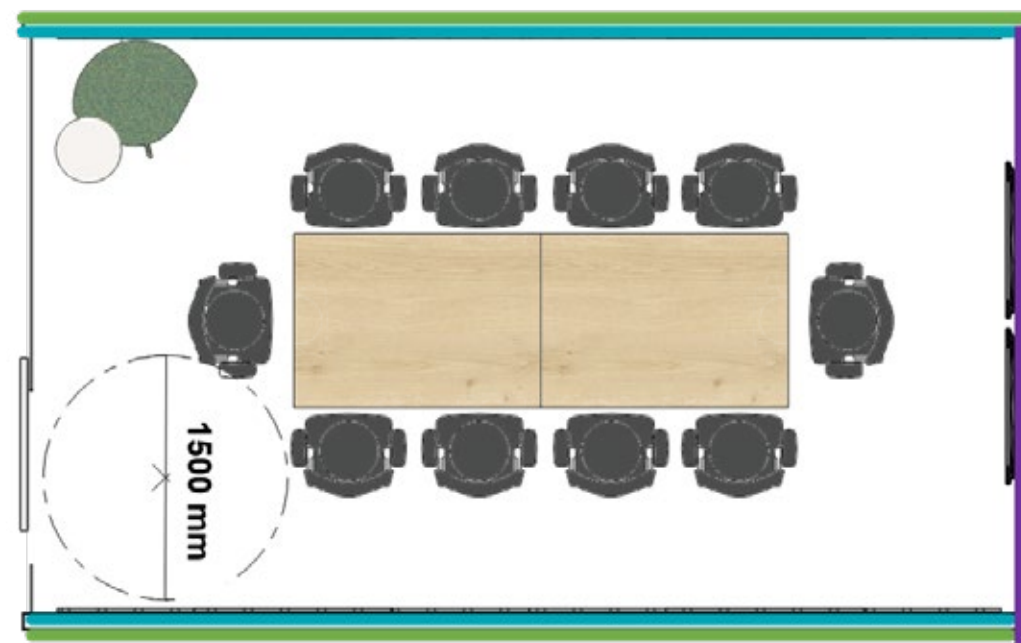

Standard Plan View

- Tackable Acoustic Panels
- Writable Surface
- Primary infrastructure wall

#### 4.7.7 Medium Meeting C

##### General Information

**Size:**  
Maximum 20'-0" x 12'-0" (240 USF)  
*Calculated from the center of the walls*

**Occupancy:**  
10-person

##### Accessibility Requirements:

- » AODA / OBC compliant
- » Provide at least one seat with 900 mm clearance

##### Architectural Requirements:

- » Demountable Partitions:
  - » Full glass front with 36" wide privacy film and glass sliding door with 36" wide privacy
  - » One (1) wall to have two (2) sections of writable surface and tackable acoustic panels for all other sections (with the option to mount artwork)
  - » Acoustical privacy baffling in ceiling
  - » Fire retardant 5/8-inch plywood blocking as required for wall-hung furniture and displays

##### Location:

At core, distributed

10-person meeting room. Can be converted to two offices/small meeting room A or two small meeting room B with some construction work and furniture changes.

##### Infrastructure

###### At Surface:

- 2x Table monuments each with:
- » 2x Duplex power
  - » 2x USB-C power
  - » 1x AV
  - » 1x Data

###### Per Wall Display:

- » 2x Duplex power
- » 1x AV
- » 1x Data
- » 1x IPTV capability
- » 1x AV pathway from surface

###### Demountable Partition Door Frame:

Infrastructure (power/data) for future room booking hardware/system

###### IT/AV:

- » Prepare rough-ins to receive displays
- » Potential to mount a camera and/or collaboration bar above or below the display
- » Provide option for dual displays where space allows
- » Prepare rough-ins to receive room booking panel
- » Wi-fi throughout
- » Infrastructure and furniture to enable the GOVTechON digital workplace strategy. Please reference GO-ITS 80 and applicable KOP furniture requirements for technology

##### Furniture Requirements

- » Meeting table
- » Electrical grommet with cable management tray below surface
- » 10x Meeting chairs

## 4.8.0 ALTERNATIVE WORKSPACES (OPEN)

Workspace Type	Size	Usable Square Feet	Comments
Harvest Table	8'-0" x 4'-0"	Minimum 32 Maximum 64	1-8-person meeting table in an open workspace.
Open Collaboration A	10'-0" x 10'-0"	Minimum 100 Maximum 120	1-4-person casual meeting setting in open area.
Open Collaboration B	7'-0" x 7'-0"	Minimum 49 Maximum 100	3-4-person casual meeting setting in open area.
Open Collaboration C1	15'-0" x 3'-0"	Minimum 45 Maximum 50	1-2-person casual meeting setting in open area.
Open Collaboration C2	15'-0" x 6'-0"	Minimum 90 Maximum 100	4-8-person casual meeting setting in open area.
Open Collaboration D	16'-0" x 14'-0"	Minimum 224 Maximum 240	2-8-person casual meeting setting in open area.
Open Collaboration E	7'-0" x 7'-0"	Minimum 49 Maximum 100	1-3-person casual meeting setting in open area.
Open Collaboration F	7'-0" x 7'-0"	Minimum 49 Maximum 100	2-person casual meeting setting in open area.
Focus Lounge	6'-0" x 10'-0"	Maximum 60	Individual space for work or reprise in an open area.

*\*\* Please note that the furniture finishes in the following images are for illustrative purposes only and the final product may vary based on the furniture vendor selected.*



Isometric View of Harvest Table

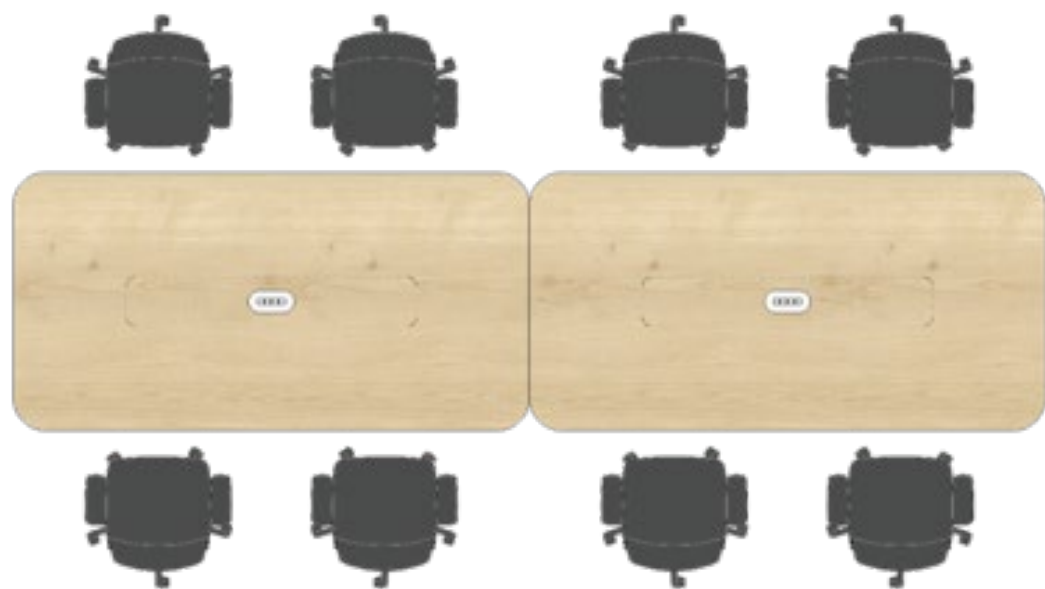

Standard Plan View of Harvest Table

#### 4.8.1 Harvest Table

##### General Information

**Size:**  
Minimum 8'-0" x 4'-0" (32 USF)  
(Maximum 64 USF)

**Occupancy:**  
1-8-person

##### Accessibility Requirements:

- » AODA / OBC compliant
- » Provide at least one seat with 900 mm clearance

##### Location:

Open areas, adjacent to collaboration areas

1-8-person meeting table in an open workspace.

##### Infrastructure

##### Per 4 persons, at surface:

- » 2x USB-C power
- » 2x Duplex power

##### Floor Monument below surface:

2x Duplex power

##### IT/AV:

- » Wi-fi throughout
- » Infrastructure and furniture to enable the GOVTechON digital workplace strategy. Please reference GO-ITS 80 and applicable KOP furniture requirements for technology

##### Furniture Requirements

- » Harvest Table
- » 8x Task chairs
- » 4'-0" of table space per chair
- » Electrical grommet to accommodate two duplex power and two USB-C with cable management tray below surface



Isometric View

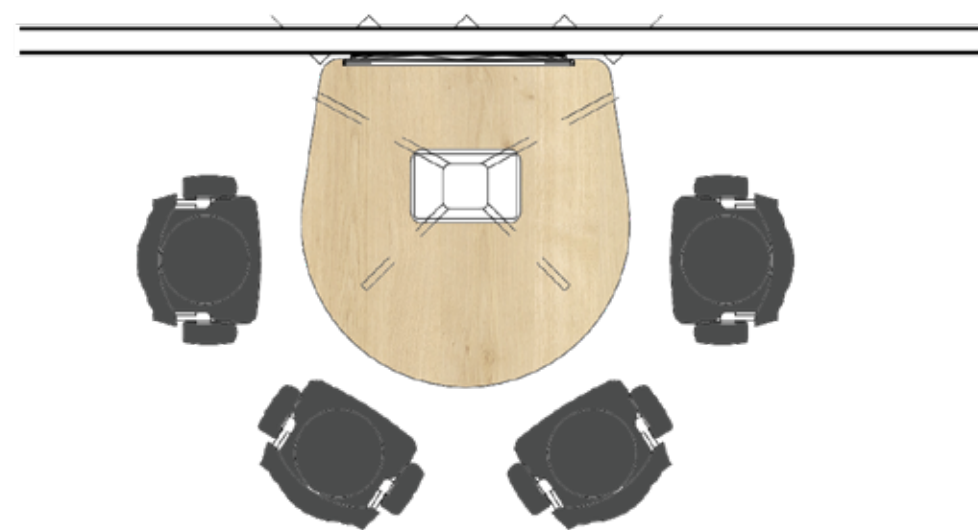

Standard Plan View

## 4.8.2 Open Collaboration A

### General Information

**Size:**  
Minimum 10'-0" x 10'-0" (100 USF)  
(Maximum 120 USF)

**Occupancy:**  
1-4-person

### Accessibility Requirements:

- » AODA / OBC compliant
- » Provide at least one seat with 900 mm clearance at each setting

### Architectural Requirements:

If mounted on a Gypsum Wall Board partition, 5/8" plywood blocking to support display

### Location:

Open areas, not adjacent to focus space

1-4-person casual meeting setting in open area.

### Infrastructure

#### At Surface:

- » 2x Duplex power
- » 1x USB-C power
- » 1x Data

#### Per Wall Display:

- » 2x Duplex power
- » 1x Data
- » 1x AV pathway

#### IT/AV:

- » Potential for collaboration bar to be installed
- » Provide capabilities for soft-codec VTC using displays and USB cameras, annotation on one of two displays where there are two
- » Provide for screen-cast from bring your own device per display
- » Wi-fi throughout
- » Infrastructure and furniture to enable the GOVTechON digital workplace strategy. Please reference GO-ITS 80 and applicable KOP furniture requirements for technology

### Furniture Requirements

- » Height adjustable D-shape surface
- » 4x Stool task chairs
- » Electrical grommet to accommodate 2x Duplex power, 1x USB-C, 1x Data, 1x IPTV, and 1x AV port with cable management tray below surface



Isometric View

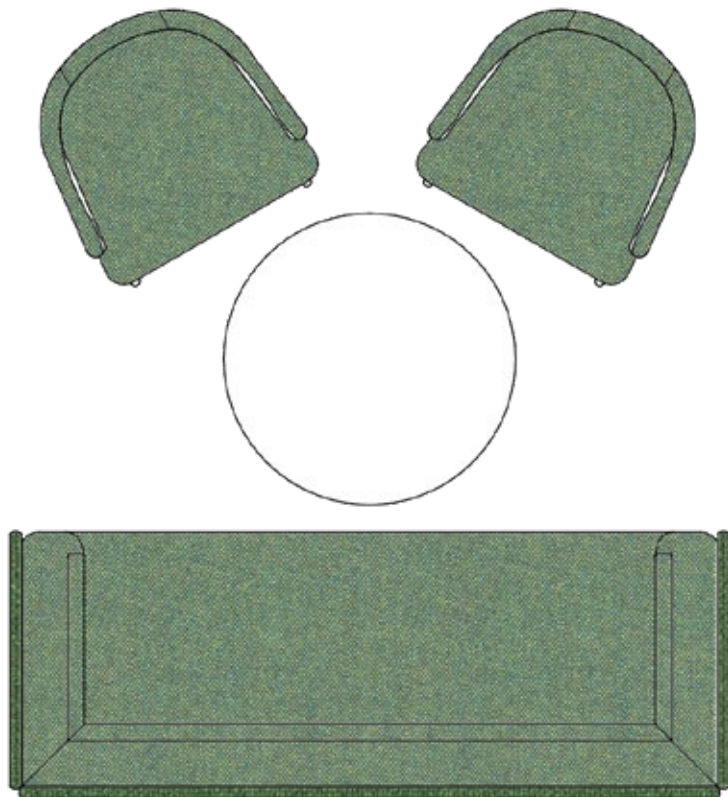

Standard Plan View

### 4.8.3 Open Collaboration B

3-4-person casual meeting setting in open area

#### General Information

**Size:**  
Minimum 7'-0" x 7'-0" (49 USF)  
(Maximum 100 USF)

**Occupancy:**  
3-4-person

**Accessibility Requirements:**

- » AODA / OBC compliant
- » Provide at least one seat with 900 mm clearance

**Architectural Requirements:**  
N/A

**Location:**  
Open areas, not adjacent to focus space

#### Infrastructure

**Floor Monument Below Surface:**

- » 2x Duplex power
- » 1x USB-C power

**IT/AV:**

- » Wi-fi throughout
- » Infrastructure and furniture to enable the GOVTechON digital workplace strategy. Please reference GO-ITS 80 and applicable KOP furniture requirements for technology

#### Furniture Requirements

- » Modular sofa – high back
- » Task-height table
- » 2x Task-height lounge chairs



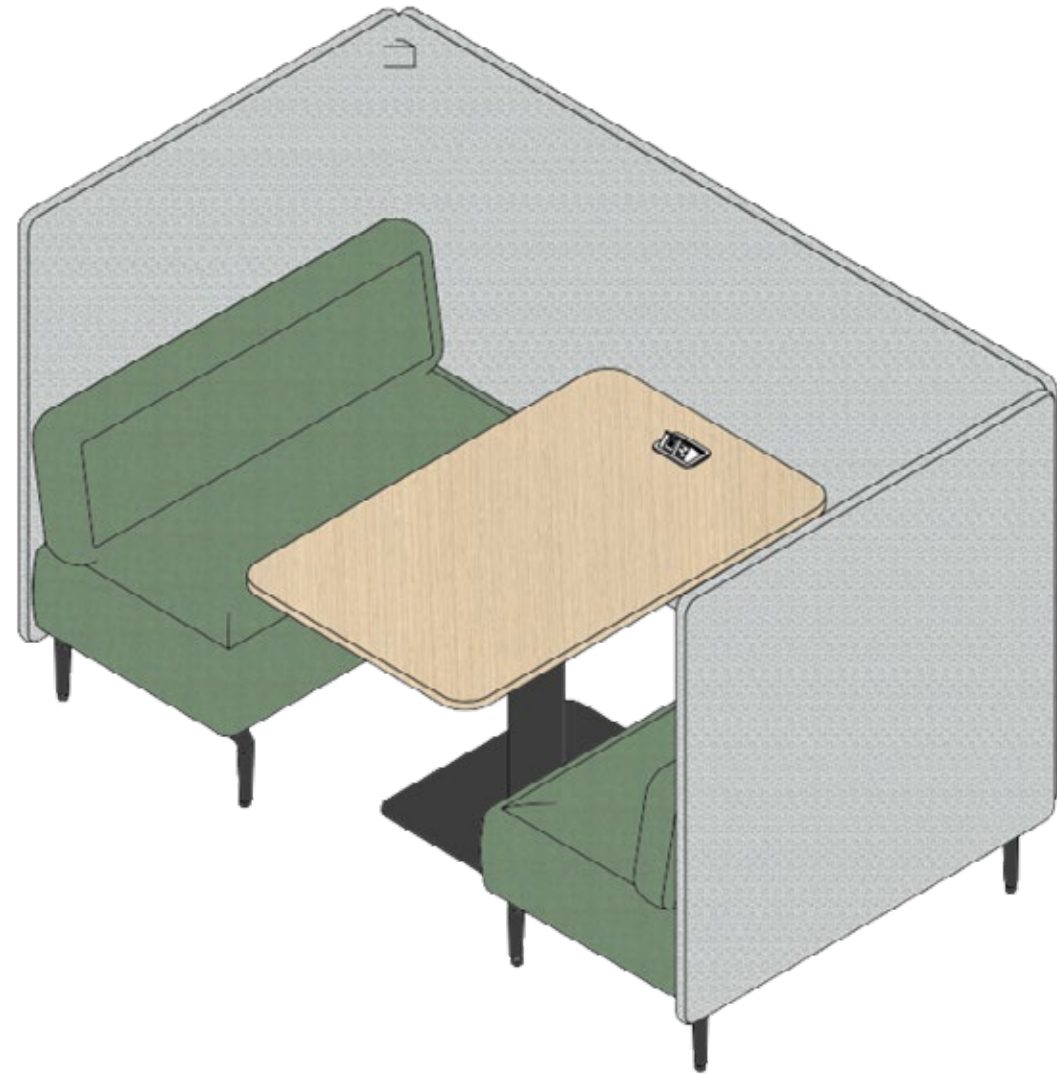

Isometric View

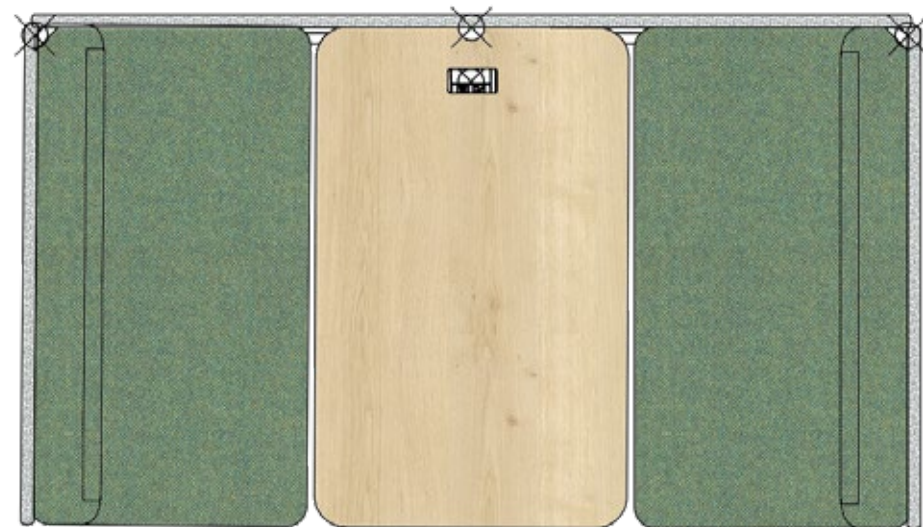

Standard Plan View

#### 4.8.4 Open Collaboration C1

1-2-person casual meeting setting in open area

##### General Information

**Size:**  
Minimum 15'-0" x 3'-0" (45 USF)  
(Maximum 50 USF)

**Occupancy:**  
1-2-person

##### Accessibility Requirements:

- » AODA / OBC compliant
- » Provide at least one seat with 900 mm clearance

##### Architectural Requirements:

If mounted on GWB partition, 5/8" plywood blocking to support display

##### Location:

Open areas, not adjacent to focus space

##### Infrastructure

###### At Surface:

- » 2x Duplex power
- » 1x USB-C power

###### Per Wall Display (if present):

- » 2x Duplex power
- » 1x Data
- » 1x AV
- » 1x AV pathway from surface

###### IT/AV:

- » Wi-fi throughout
- » Infrastructure and furniture to enable the GOVTechON digital workplace strategy. Please reference GO-ITS 80 and applicable KOP furniture requirements for technology

##### Furniture Requirements

- » High panel banquette sofa
- » Work-height table

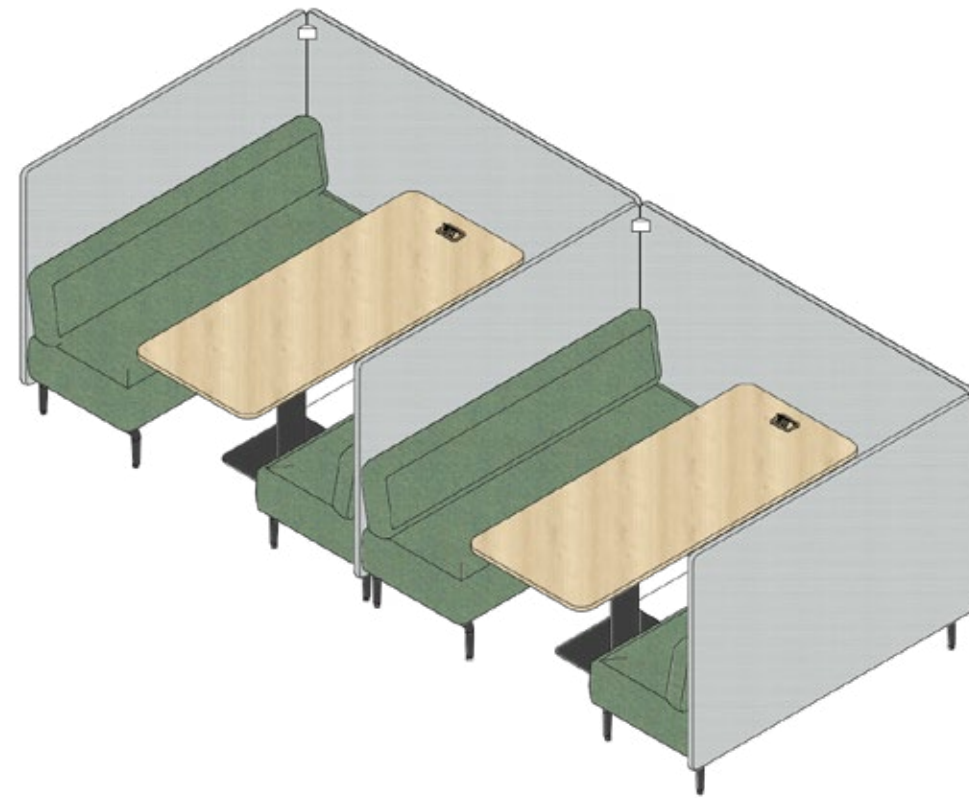

Isometric View

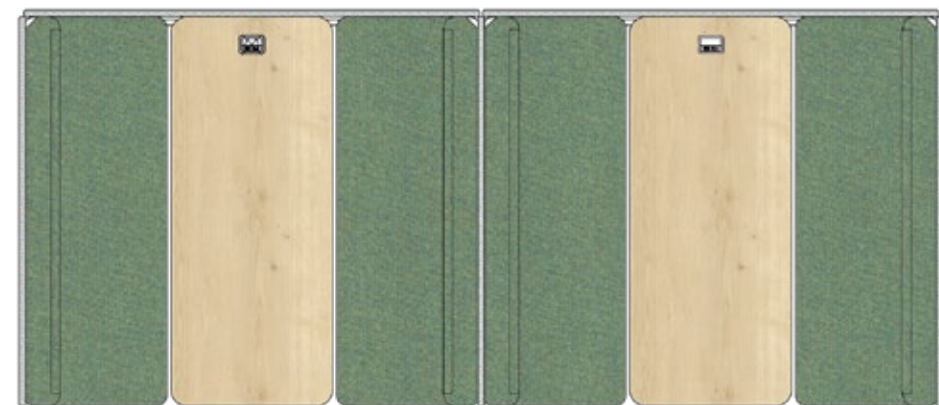

Standard Plan View

#### 4.8.5 Open Collaboration C2

4-8-person casual meeting setting in open area

##### General Information

**Size:**  
Minimum 15'-0" x 6'-0" (90 USF)  
(Maximum 100 USF)

**Occupancy:**  
4-8-person

**Accessibility Requirements:**

- » AODA / OBC compliant
- » Provide at least one seat with 900 mm clearance

**Architectural Requirements:**  
If mounted on GWB partition, 5/8" plywood blocking to support display

**Location:**  
Open areas, not adjacent to focus space

##### Infrastructure

**At Surface:**

- » 2x Duplex power
- » 1x USB-C power

**Per Wall Display (if present):**

- » 2x Duplex power
- » 1x Data
- » 1x AV
- » 1x AV pathway from surface

**IT/AV:**

- » Wi-fi throughout
- » Infrastructure and furniture to enable the GOVTechON digital workplace strategy. Please reference GO-ITS 80 and applicable KOP furniture requirements for technology

##### Furniture Requirements

- » High panel banquette sofa
- » Work-height table

#### 4.8.6 Open Collaboration D

2-8-person casual meeting setting in an open area

##### General Information

**Size:**  
Minimum 16'-0" x 14'-0" (224 USF)  
(Maximum 240 USF)

**Occupancy:**  
2-8-person

##### Accessibility Requirements:

- » AODA / OBC compliant
- » Provide at least one seat with 900 mm clearance

##### Architectural Requirements:

N/A

##### Location:

Open areas, not adjacent to focus space

##### Infrastructure

##### Floor Monument Per Table:

2x Duplex power

##### At Surface:

- » 2x Duplex power
- » 1x USB-C power

##### IT/AV:

- » Wi-fi throughout
- » Infrastructure and furniture to enable the GOVTechON digital workplace strategy. Please reference GO-ITS 80 and applicable KOP furniture requirements for technology

##### Furniture Requirements

- » Work height table (rectangle)
- » Work-height table (round)
- » 6x Meeting chairs
- » 2x Lounge chairs on casters
- » Free standing privacy screen
- » Grommet hole on table with cable management tray below surface

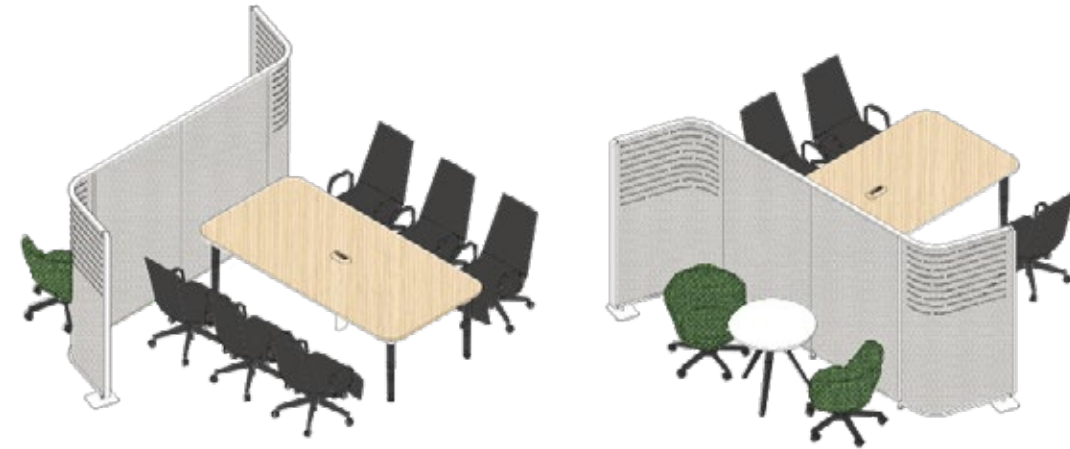

Isometric View

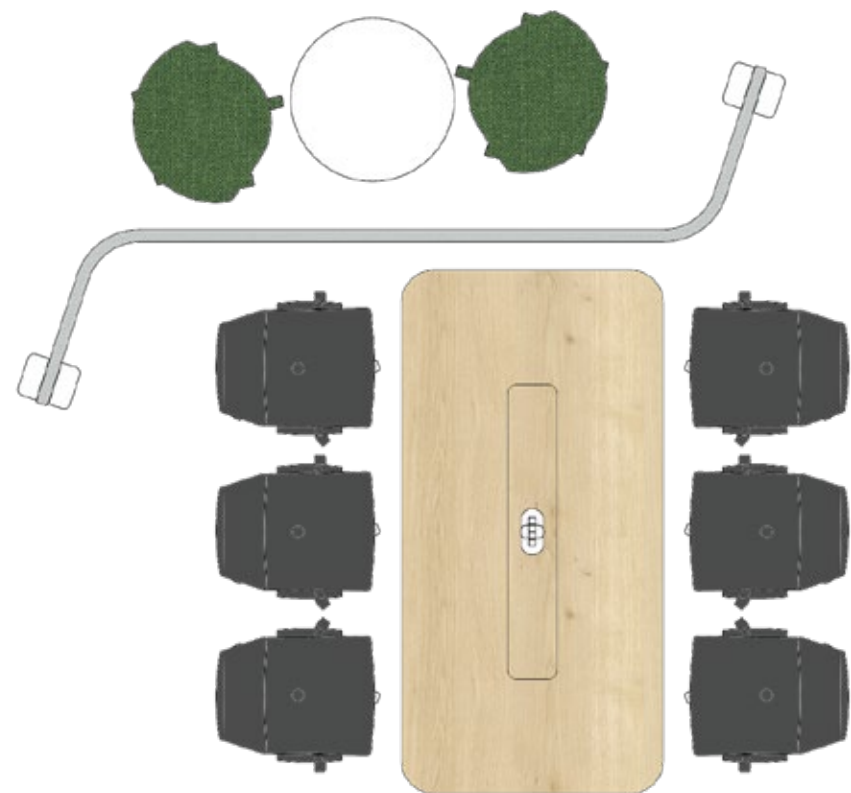

Standard Plan View



Isometric View

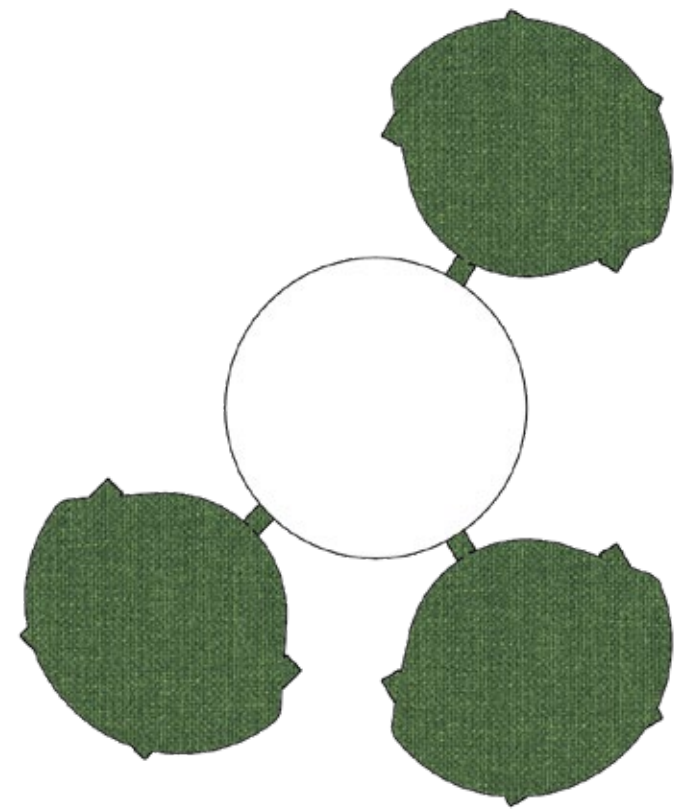

Standard Plan View

#### 4.8.7 Open Collaboration E

2-3-person casual meeting setting in an open area

##### General Information

**Recommended Size:**  
Minimum 7'-0" x 7'-0" (49 USF)  
(Maximum 100 USF)

**Occupancy:**  
1-3-person

##### Accessibility Requirements:

- » AODA / OBC compliant
- » Provide at least one seat with 900 mm clearance

##### Architectural Requirements:

N/A

##### Location:

Open areas, not adjacent to focus space

##### Infrastructure

##### IT/AV:

- » Wi-fi throughout
- » Infrastructure and furniture to enable the GOVTechON digital workplace strategy. Please reference GO-ITS 80 and applicable KOP furniture requirements for technology

##### Furniture Requirements

- » Lounge chairs on casters (star base)
- » Work-height table

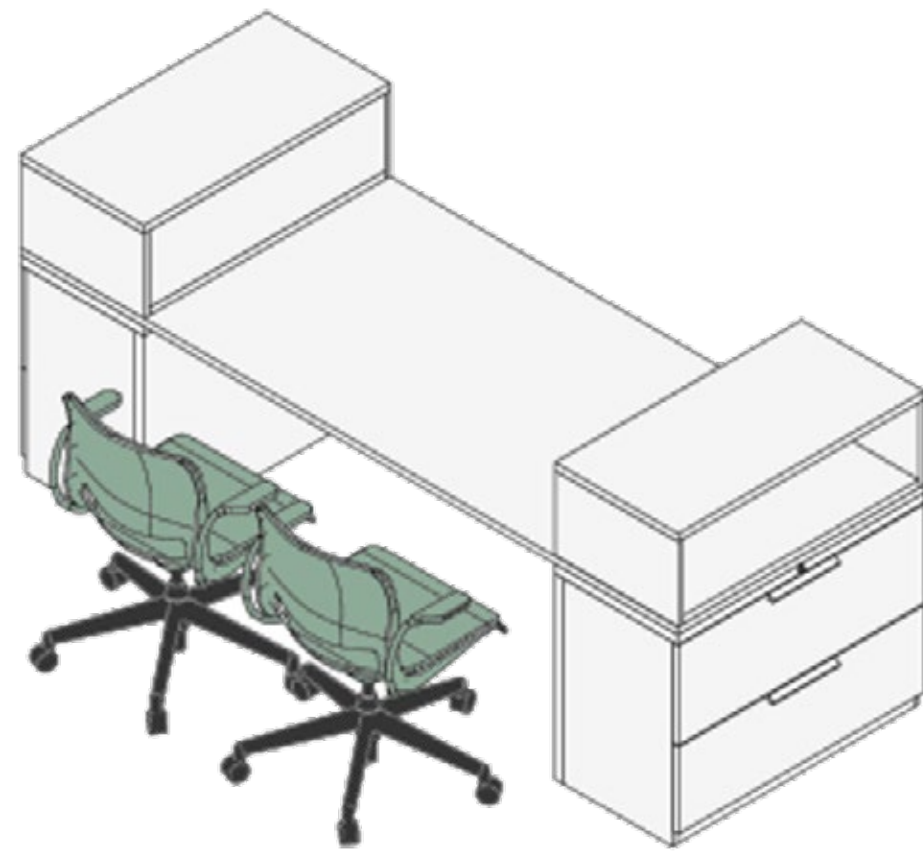

Isometric View

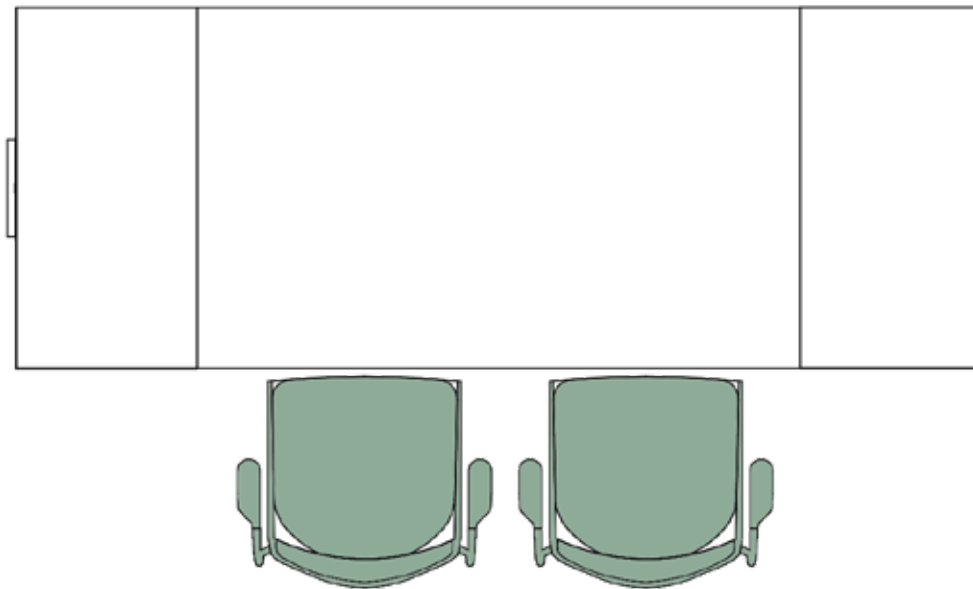

Standard Plan View

#### 4.8.8 Open Collaboration F

2-person casual meeting setting in an open area

##### General Information

**Size:**  
Minimum 7'-0" x 7'-0" (49 USF)  
(Maximum 100 USF)

**Occupancy:**  
2-person

**Accessibility Requirements:**  
AODA / OBC compliant

**Architectural Requirements:**  
N/A

**Location:**  
Open areas, at the end of a run of workstations

##### Infrastructure

**IT/AV:**

- » Wi-fi throughout
- » Infrastructure and furniture to enable the GOVTechON digital workplace strategy. Please reference GO-ITS 80 and applicable KOP furniture requirements for technology

##### Furniture Requirements

- » Work-height surface
- » 2x Chairs on castors
- » 2x Lateral filing cabinets

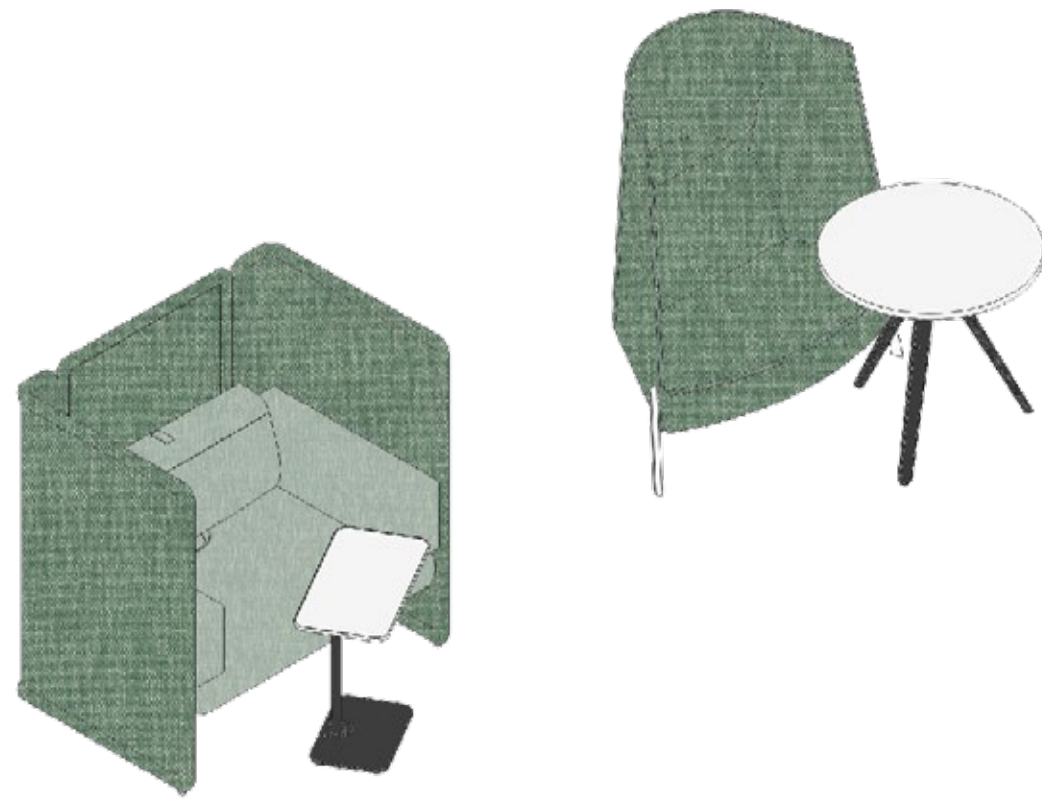

Isometric View

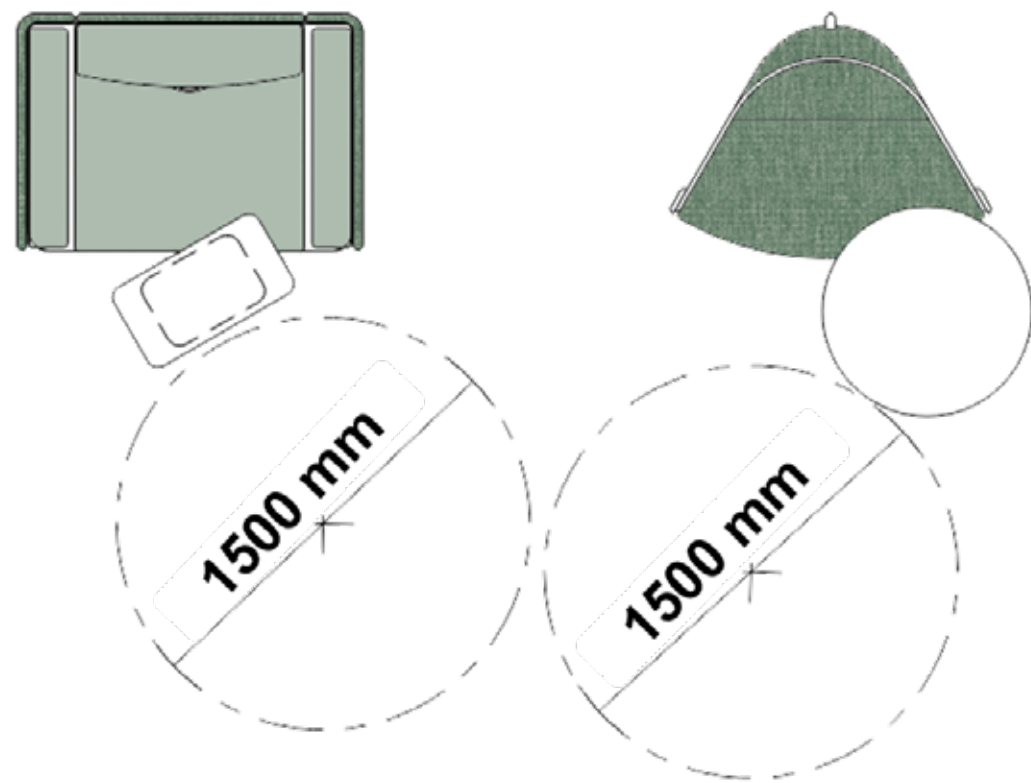

Standard Plan View

#### 4.8.9 Focus Lounge

Individual space in open areas work or reprise

##### General Information

**Size:**  
Maximum 6'-0" x 10'-0" (60 USF)

**Occupancy:**  
1-person

**Accessibility Requirements:**  
AODA / OBC compliant

**Architectural Requirements:**  
N/A

**Location:**  
Open areas, adjacent to work areas or near windows where possible

##### Infrastructure

**IT/AV:**

- » Wi-fi throughout
- » Infrastructure and furniture to enable the GOVTechON digital workplace strategy. Please reference GO-ITS 80 and applicable KOP furniture requirements for technology

##### Furniture Requirements

- » Furniture varies
- » Work-height surfaces
- » Ergonomic seating

## 4.9.0 SUPPORT

Workspace Type	Size	Usable Square Feet	Comments
Media Kiosk	1'-7" x 4'-0"	Maximum 10	An accessory to support AV components in areas where wall-mounted displays are not an option.
Print and Copy Room	10'-0" x 12'-0"	Maximum 120	Room that contains printer(s)/copier, as well as shredders and recycling for disposal. Storage will be provided for shared resources. To be located adjacent to filing and storage areas for easy access.
Filing and Storage Room	10'-0" x 12'-0"	Maximum 120	File area to be centralised adjacent to print/copy to support reduced paper-based work.
Lockers and Coat Area/Room	10'-0" x 12'-0"	Maximum 120	Lockers should be planned at main entrances to tenant space and are to be AODA compliant 2 high lockers, with a minimum of 2%-5% of lockers being accessible lockers (single locker style). Coat closets should be planned at the main entrance to the tenant space and locker area. Coat closet should include an accessible height coat rod. Ottomans should be provided for staff to place items while using lockers. If space allows, waste disposal should be added with lockers and should include recycling and waste. Area/room with coat closets, boot storage, and seating.

*\* Measurements for all enclosed spaces are center of walls.*

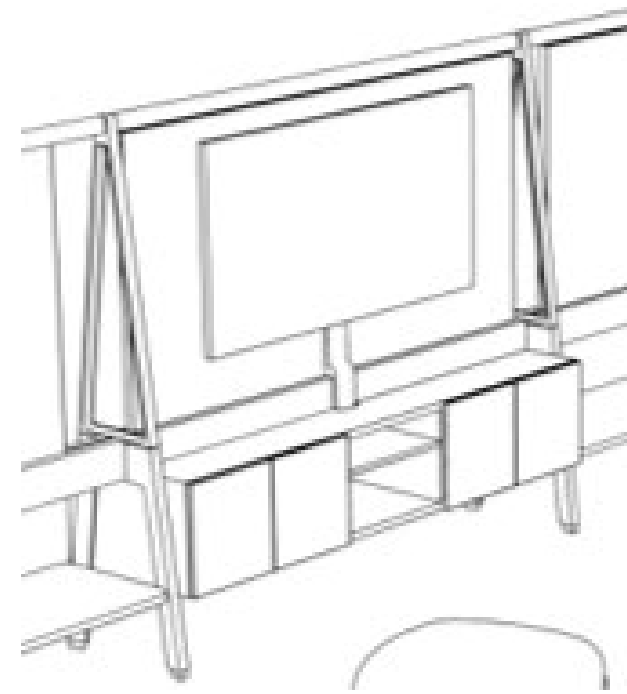

Isometric View



Isometric View - image of table and chairs for display purposes only



Standard Plan View

#### 4.9.1 Media Kiosk

##### General Information

**Size:**  
Maximum 1'-7" x 4'-0" (6.8 USF)  
(Maximum: 10 USF)

**Occupancy:**  
N/A

**Accessibility Requirements:**  
N/A

**Architectural Requirements:**  
N/A

**Location:**

- » Meeting rooms
- » Heritage suite

An accessory to support AV components in areas where wall mounted displays are not an option.

##### Infrastructure

**Per Kiosk:**

- » 2x Duplex power
- » 1x Data
- » 1x AV pathway

##### IT/AV:

- » Wi-fi throughout
- » Potential to mount a camera and/or collaboration bar above or below the display
- » Infrastructure and furniture to enable the GOVTechON digital workplace strategy. Please reference GO-ITS 80 and applicable KOP furniture requirements for technology

##### Furniture Requirements

- » Free-standing kiosk for LCD/AV display
- » Kiosk to be on castors which are lockable
- » Open and closed storage
- » Closed storage to have locks



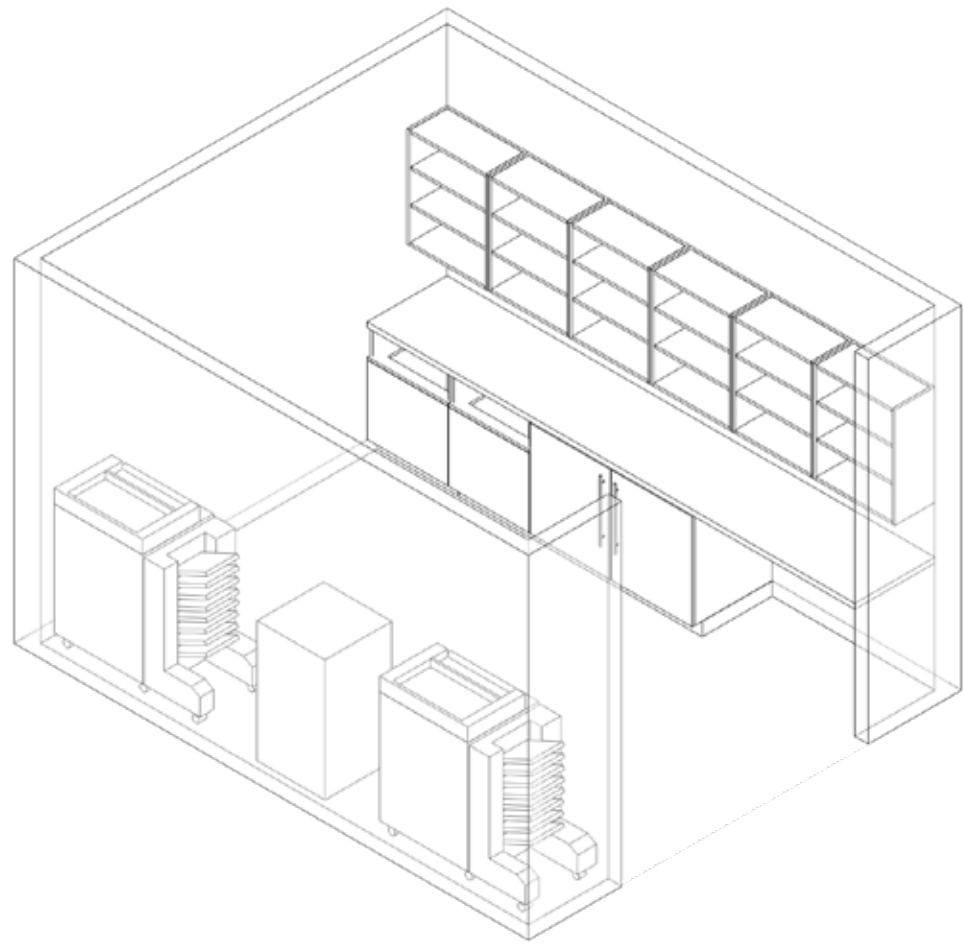

Isometric View

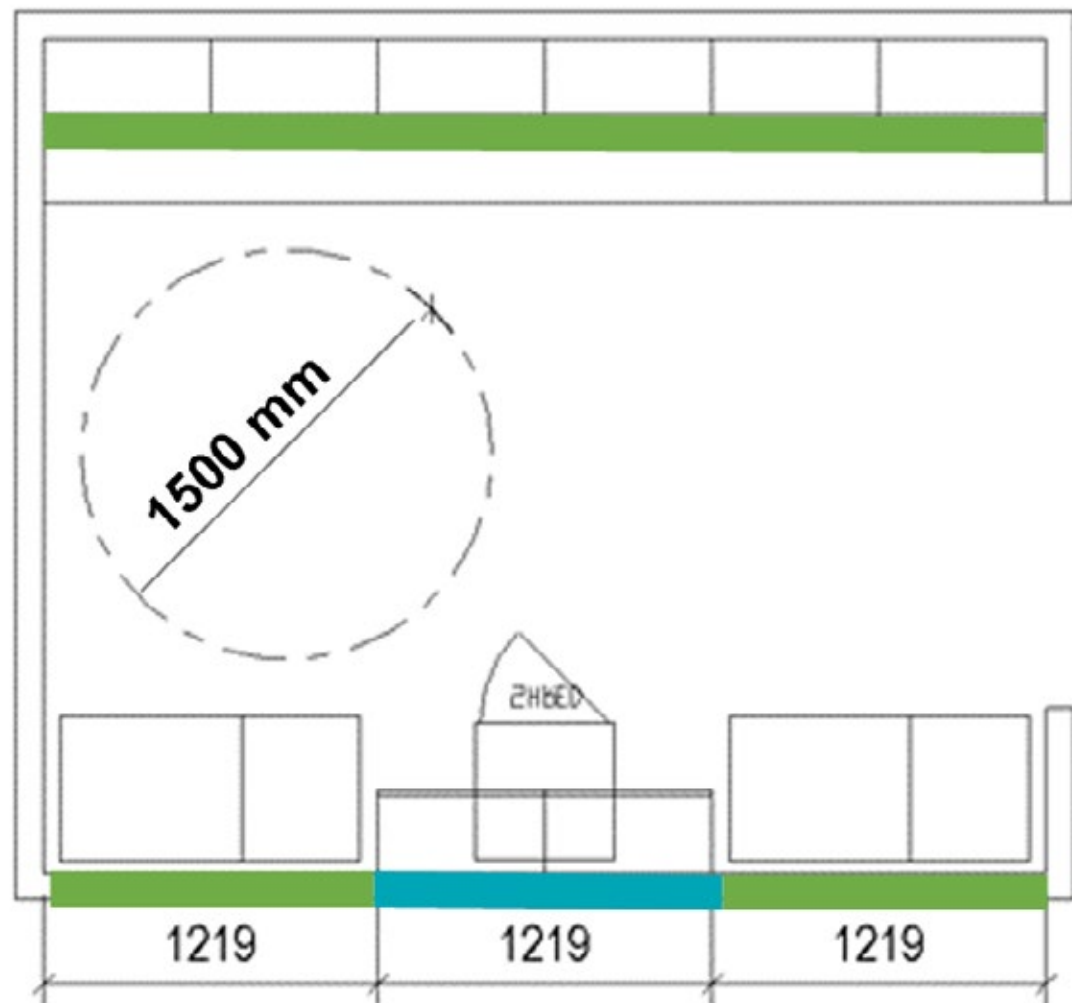

Standard Plan View

- Tackable Acoustic Panels
- Writable Surface

#### 4.9.2 Print and Copy Room

##### General Information

**Size:**  
Maximum 10'-0" x 12'-0" (120 USF)  
Calculated from the center of the walls

**Occupancy:**  
N/A

**Accessibility Requirements:**  
AODA / OBC compliant

##### Architectural Requirements:

- » Negative pressure ventilation
- » Demountable Partitions:
  - » Two (2) walls (storage and printer/copier walls) to have tackable acoustic panels
  - » One (1) wall (printer/copier wall) to have writable surface
  - » Acoustical privacy sound absorptive insulation with baffling in ceiling
  - » Fire retardant 5/8-inch plywood blocking as required for wall-hung furniture

##### Location:

At the core of the building, near other support spaces

Some printing is still required in a reduced paper environment, the print room will house equipment to support this, as well as shredders and recycling for disposal. Storage will be provided for shared resources. To be located adjacent to filing and storage areas for easy access.

##### Infrastructure

- » 1x Dedicated T-slot duplex power per printer
- » 1x Data per printer
- » 2x Analog Plain Old Telephone Service (phone and fax)

##### At Counter:

- 3x Locations of:
- » 1x Duplex power
  - » 1x Data

##### IT/AV:

- » Wi-fi throughout
- » Infrastructure and furniture to enable the GOVTechON digital workplace strategy. Please reference GO-ITS 80 and applicable KOP furniture requirements for technology

##### Furniture Requirements

- » 1x Free-standing secure shredder (by tenant)
- » 2x Multi-Function Device Floor Model (by tenant)
- » Wall-mounted upper storage with open shelving
- » Countertop (standard height with accessible portion)
- » 1x Waste below counter
- » 1x Recycling below counter
- » Remaining below counter to be closed cabinets with opening for accessible portion of counter

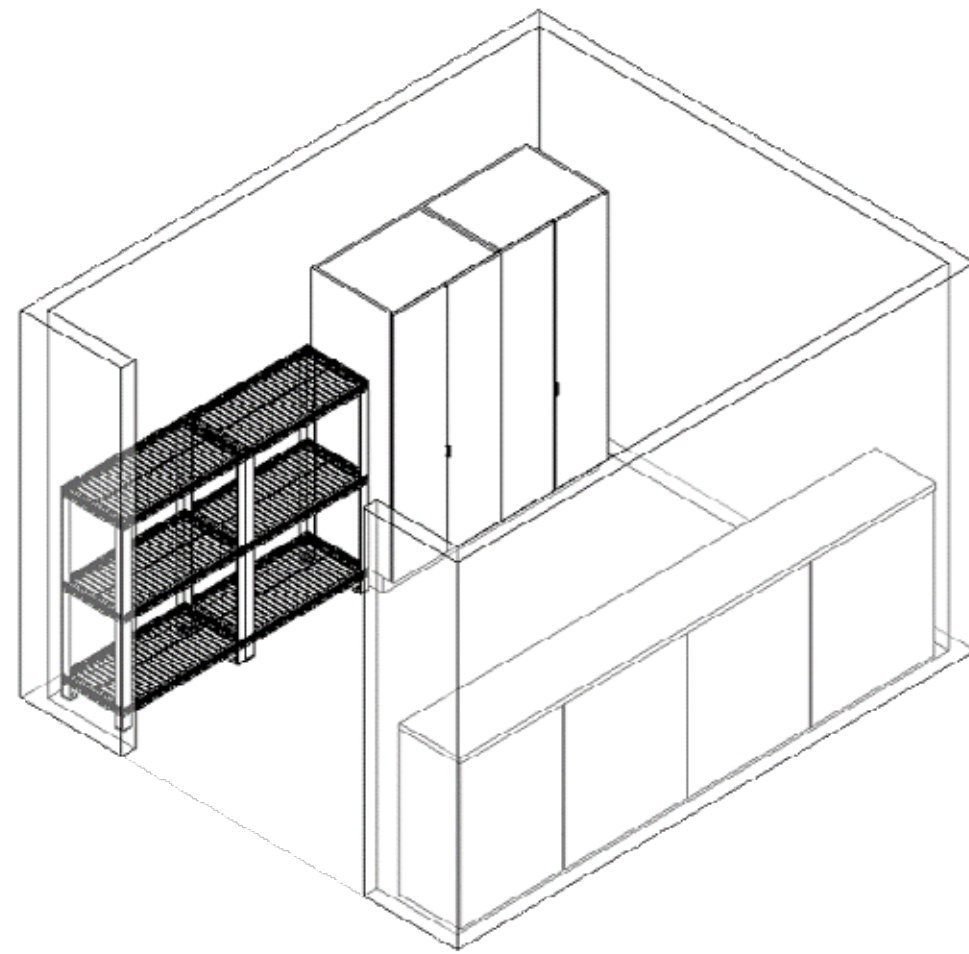

Isometric View

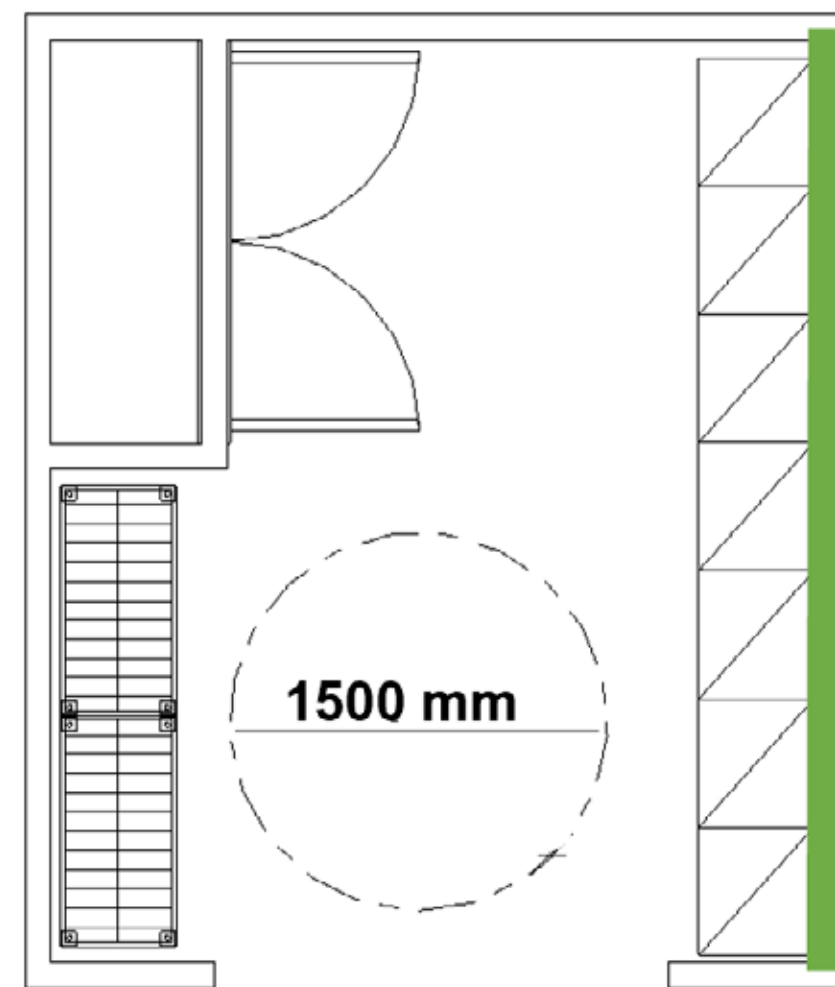

Standard Plan View

### 4.9.3 Filing and Storage Room

File area to be centralized and adjacent to print/copy to support reduced paper-based work.

#### General Information

**Size:**  
Maximum 10'-0" x 12'-0" (120 USF)  
Calculated from the center of the walls

**Occupancy:**  
N/A

**Accessibility Requirements:**  
AODA / OBC compliant

#### Architectural Requirements:

- » Demountable Partitions:
  - » One (1) wall (storage wall) to have tackable panels
  - » Fire retardant 5/8-inch plywood blocking above storage wall for future wall-hung furniture

**Location:**  
At core

#### Infrastructure

- » Power/data to match print/copy locations for future conversion
- » Convenience power

#### IT/AV:

- » Wi-fi throughout
- » Infrastructure and furniture to enable the GOVTechON digital workplace strategy. Please reference GO-ITS 80 and applicable KOP furniture requirements for technology

#### Furniture Requirements

- » Open shelving
- » Lateral filing storage with common top (4x - 3 high, 3x - 2 high)
- » Free-standing secure storage closet with adjustable shelves (one side to be accessible)

— Tackable Acoustic Panels

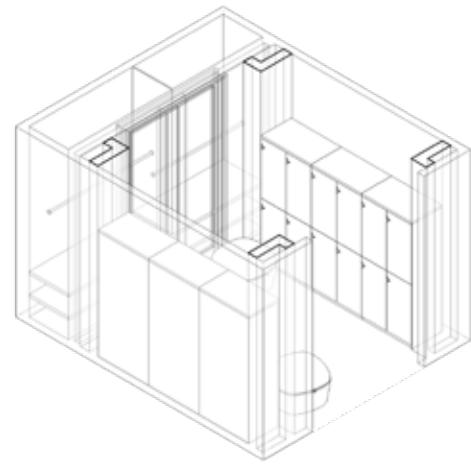

Isometric view of Lockers and Coat Closet

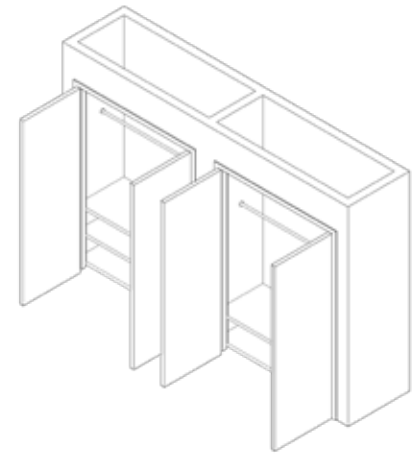

Isometric View of Coat Closet

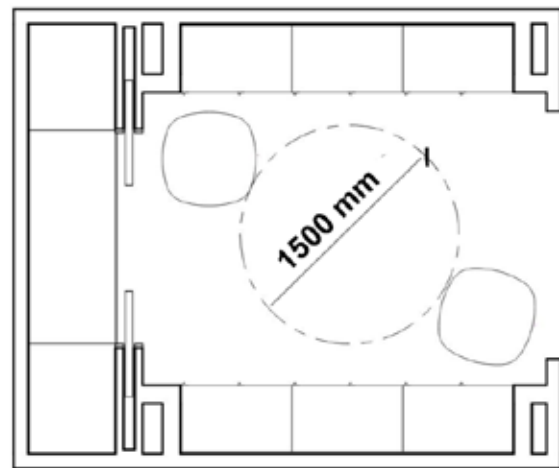

Standard Plan View of Lockers and Coat Closet

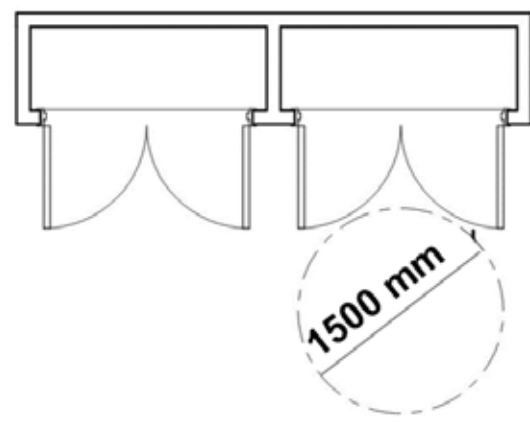

Standard Plan View of Coat Closet

#### 4.9.4 Lockers and Coat Area/Room

##### General Information

###### Size:

Minimum 10'-0" x 12'-0" (120 USF)

Refer to floor plan layouts

Calculated from the center of the walls

###### Occupancy:

N/A

###### Accessibility Requirements:

- » AODA / OBC compliant
- » Accessible height coat rod that spans approximately 2'-0" of closet

###### Architectural Requirements:

- » At Corridor: 5/8" gyp. board, 3-5/8" metal stud with sound absorptive insulation, 5/8" gyp board, from slab to underside of ceiling
- » At Adjacent Spaces: 5/8" gyp. board, 3-5/8" metal stud with sound absorptive insulation, 5/8" gyp board, from slab to underside of ceiling, acoustic baffle above.
- » Fire retardant blocking as required
- » Accessible height coat rod to span approximately 2'-0" of closet
- » Infrastructure and furniture to enable the GOVTechON digital workplace strategy. Please reference GO-ITS 80 and applicable KOP furniture requirements for technology

###### Location:

At core

All lockers are to be AODA compliant. Lockers and coat closets can be planned in open or enclosed areas depending on architectural fit. Lockers and coat closets should be planned in close proximity to each other whenever possible.

##### Infrastructure

If required, to be coordinated with requirements for locker system

##### Furniture Requirements

- » 2x High lockers and with minimum 2%-5% accessible lockers
- » Locker system – mechanical locks, black locks with white numbering for contrast
- » Moveable seating
- » Coat closet(s): boot storage and coat rails

## 4.10.0 COMMON SHARED SPACES

Workspace Type	Size	Usable Square Feet	Comments
Common Shared Working Lounge	Varies by building and project	8 USF per workspace	To be used for when headcount is over 50. Under 50 use the refuel option.
Common Shared Meeting Room	29'-0" x 14'-0"	Maximum 420	Adjacent to elevator lobby and common shared Working Lounge within a floor plate.
Universal Washroom	10'-0" x 12'-0"	Maximum 120	Adjacent to elevator lobby and common shared elements within a floor plate.
Common Shared Wellness/First Aid Room	Varies by building and project	Varies by building and project	A dedicated space intended to promote relaxation, stress reduction, and self-care to support the physical and mental well-being of all OPS employees, As per the Revised Regulations of Ontario (RRO) Reg1101: (First Aid Requirements) a dedicated wellness/first aid room is required in buildings/ complexes with 200 or more employees. The Guideline on First Aid requirements in the OPS, October 2015 should also be referenced for required first aid kits and supplies (based on estimated maximum occupancy).
Common Shared Single-User Quiet Room with Ablution Station	10'-0" x 12'-0" varies by building and project	Maximum 120 varies by building and project	An inclusive and comfortable space for all OPS employees to use in a quiet manner for reflection, contemplation, meditation or personal prayer during the workday.
Common Shared Multi-User Quiet Room with Ablution Stations	18'-0" x 20'-0" varies by building and project	Maximum 345 varies by building and project	An inclusive and comfortable space for all OPS employees to use in a quiet manner for reflection, contemplation, meditation or personal prayer during the workday.
Common Shared Single-User Quiet Room	10'-0" x 12'-0" varies by building and project	Maximum 120 varies by building and project	An inclusive and comfortable space for all OPS employees to use in a quiet manner for reflection, contemplation, meditation or personal prayer during the workday.
Common Shared Multi-User Quiet Room	18'-0" x 20'-0" varies by building and project	Maximum 345 varies by building and project	An inclusive and comfortable space for all OPS employees to use in a quiet manner for reflection, contemplation, meditation or personal prayer during the workday.
Ceremonial Room	varies by building and project	varies by building and project	The Ceremonial room can be used to accommodate Indigenous and other Sacred Ceremonies, as well as meetings and training sessions.

\* Measurements for all enclosed spaces are center of walls.

\*\* Please note that the furniture finishes in the following images are for illustrative purposes only and the final product may vary based on the furniture vendor selected.



Isometric View of Working Lounge  
 Note: Colour dependant on project and strategy.

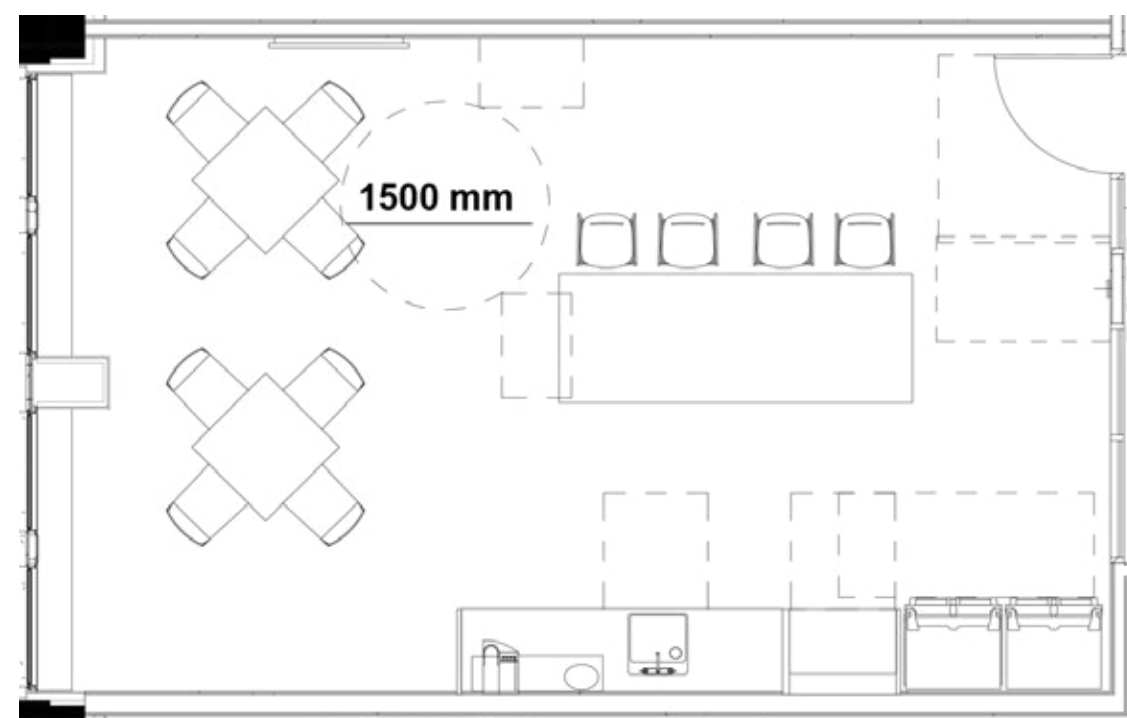

Standard Plan View of Working Lounge with 1500 mm turning circle

#### 4.10.1 Common Shared Working Lounge

##### General Information

**Recommended Size:**  
 8 USF per workspace  
 Varies depending on the site and project

**Occupancy:**  
 Varies according to the size of the room

- Accessibility Requirements:**
- » Wheelchair accessible spot at the table to have minimum 900 mm width clearance
  - » AODA / OBC compliant

- Architectural Requirements:**
- » Resilient flooring and base
  - » Upper and lower cabinets
  - » solid surface countertop
  - » Residential high-grade appliances: microwave, side-by-side refrigerator/freezer, dishwasher
  - » Spigot for filtered water
  - » Under counter water filtration system

- Location:**
- » Near washrooms and common shared meeting room
  - » Centrally located and accessible to all people within the building

##### Infrastructure

- » Electrical services to suit final kitchenette equipment requirements and layout
- » 2x Duplex receptacles for the display monitor
- » 1x Housekeeping receptacle
- » Receptacles at island

##### IT/AV:

- » Prepare rough-ins to receive display
- » Wi-fi throughout
- » Infrastructure and furniture to enable the GOVTechON digital workplace strategy. Please reference GO-ITS 80 and applicable KOP furniture requirements for technology

##### Furniture Requirements

- » Moveable furniture to accommodate seating for twelve (12) people; lounge café tables and chairs
- » Island w/ accessible portion, bar stool seating, cabinets, integrated power and integrated waste receptacles. Exact layout and configuration will vary from project-to-project and will be dependent onsite conditions
- » Tackboard, size: 10'-0" x 4'-0"
- » Fully accessible receptacles that follow building waste and recycling program



Isometric View of Common Shared Meeting Room  
 Note: Colour dependant on project and strategy

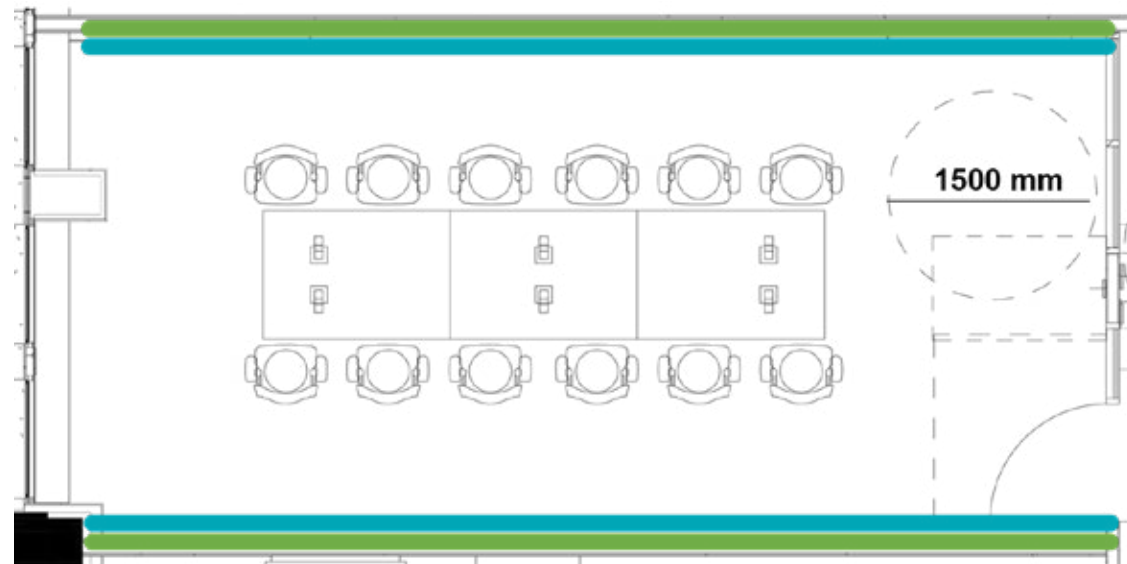

Standard Plan View of Common Shared Meeting Room

- Acoustic Panels
- Writable Surface

#### 4.10.2 Common Shared Meeting Room

##### General Information

**Recommended Size:**  
 Maximum 29'-0" x 14'-0" (420 USF)

**Occupancy:**  
 12-person

##### Accessibility Requirements:

- » Wheelchair accessible spot at table to have minimum 900 mm width clearance
- » AODA / OBC compliant

##### Architectural Requirements:

- » Carpet
- » Painted walls
- » Acoustic wall panels

##### Location:

- » Near washrooms and working lounge
- » Centrally located and accessible to all people within building

##### Infrastructure

- » Lighting control station with dimming
- » Control and pre-set buttons
- » 2x Duplex receptacles in floor box to power table
- » Assistive Listening Systems

##### Demountable Partition Door Frame:

Infrastructure (power/data) for future room booking hardware/system

##### At Surface:

- 2x Table monuments each with:
- » 2x Duplex power
  - » 2x USB-C power
  - » 1x AV
  - » 1x Data

##### Per Wall Display:

- » 2x Duplex power
- » 1x AV
- » 1x Data
- » 1x IPTV capability
- » 1x AV pathway from surface

##### IT/AV:

- » Prepare rough-ins to receive display
- » Potential to mount a camera and/or collaboration bar above or below the display
- » Provide option for dual displays where space allows
- » Prepare rough-ins to receive room booking panel
- » Wi-fi throughout

- » Infrastructure and furniture to enable the GOVTechON digital workplace strategy. Please reference GO-ITS 80 and applicable KOP furniture requirements for technology

##### Furniture Requirements

- » Credenza
- » 12-person boardroom table
- » 12x Meeting room chairs
- » Magnetic glass whiteboard

### 4.10.3 Universal Washroom

#### General Information

**Recommended Size:**  
Maximum 10'-0" x 12'-0" (120 USF)

**Occupancy:**  
N/A

#### Accessibility Requirements:

- » Washroom door to be equipped with electric strike, push to lock button.
- » Visual/audible annunciators to be provided on interior and exterior of washroom in compliance with OBC
- » Provide a clear 2500 mm turning circle

#### Architectural Requirements:

- » Porcelain tile walls and flooring
- » Door to have power door operator, lever handle closer, push to lock button, coat hook, floor stops
- » Pull string at side of toilet and emergency release on door
- » Stainless steel washroom accessories; mirror; shelf; adult change-table
- » Panic Strip
- » All washroom fixtures and handrails to be compliant with OBC
- » Power hand-dryer

#### Location:

- » Centrally located and accessible to all people within building
- » Near common shared meeting room and working lounge

#### Infrastructure

- » 1x Convenience duplex receptacle
- » 1x Power for door operator
- » 1x Power for hands-free devices
- » 1x Power for hand-dryer

#### Furniture Requirements

N/A

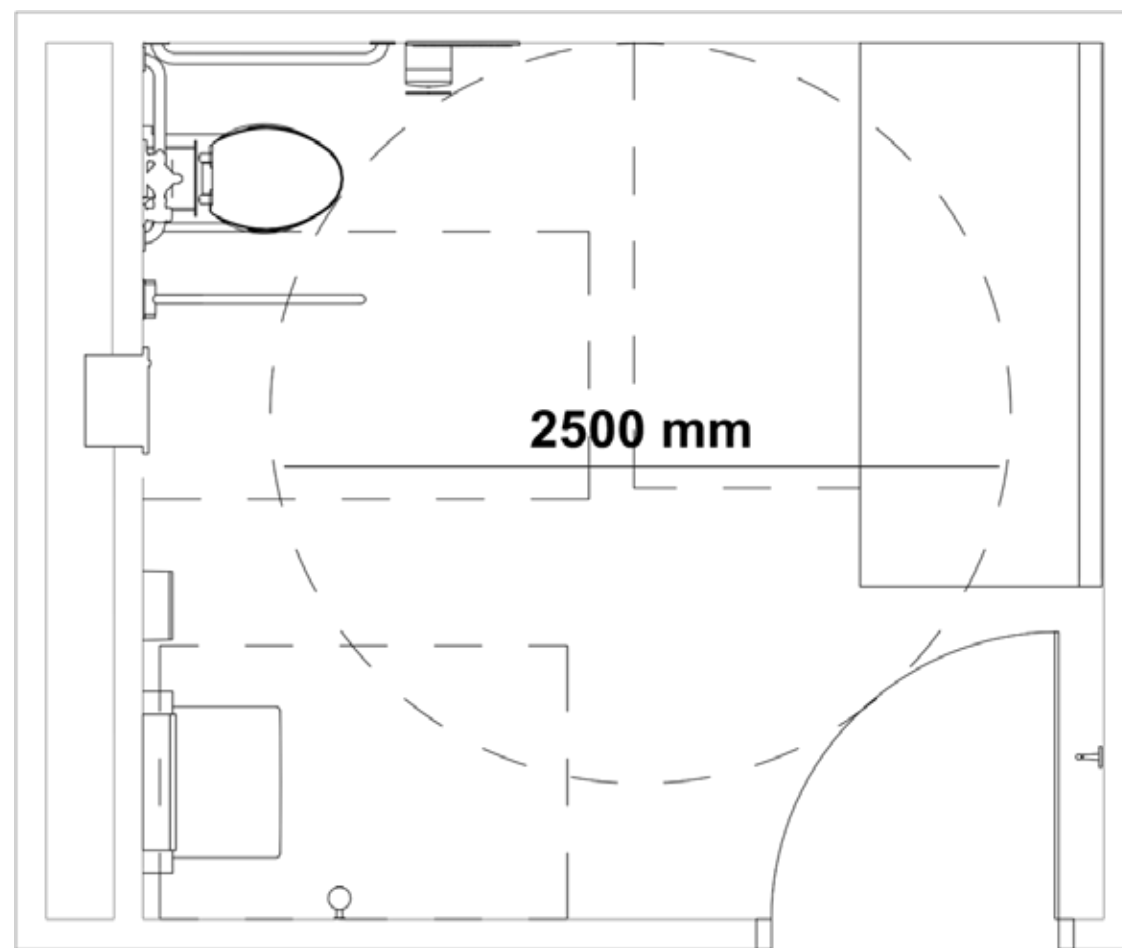

Standard Plan View

### 4.10.4 Universal Washroom Signage

#### Overhead Signage Specification

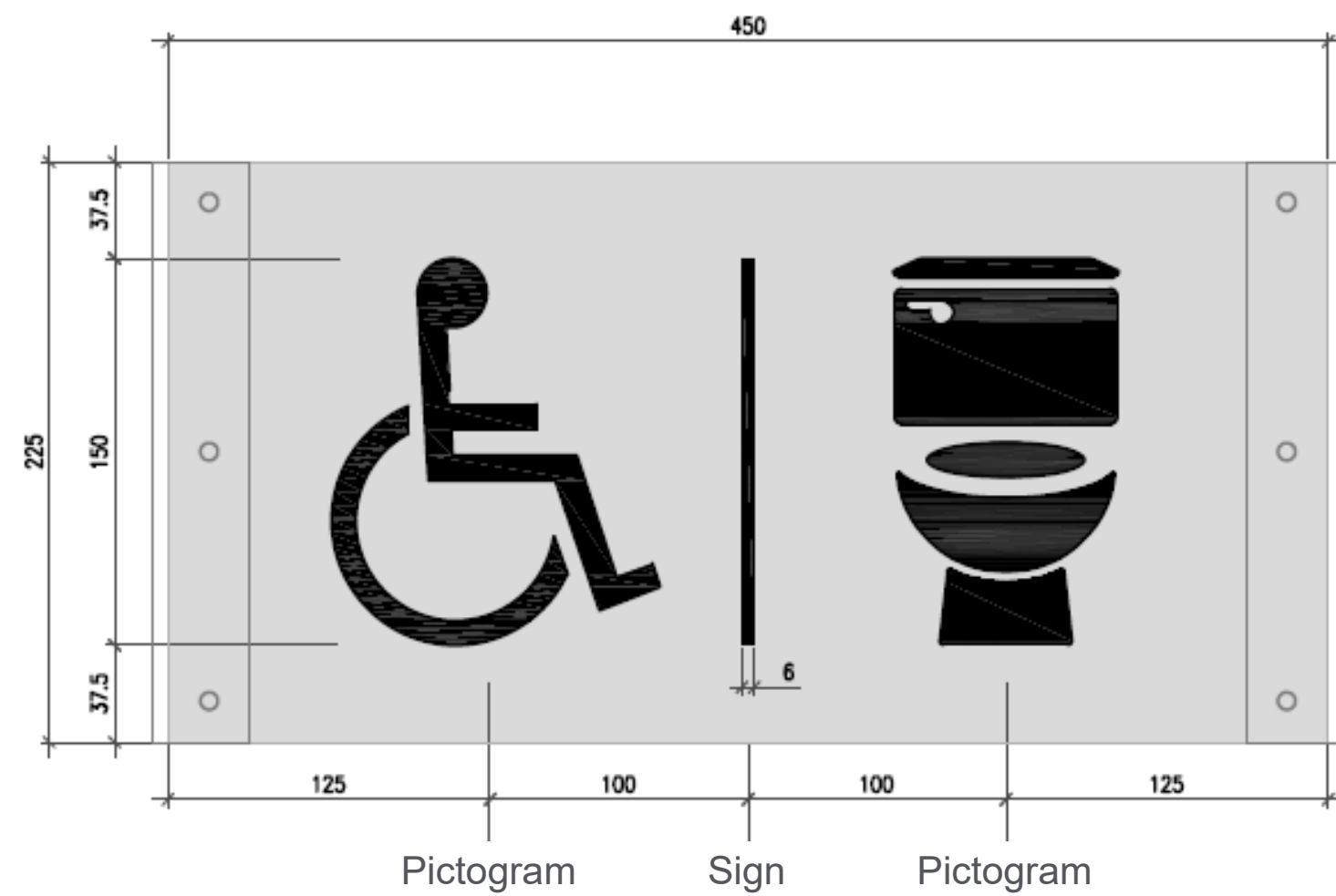

Dashed lines identify mounting angle locations. Angles required one side only.

Note: Please reference the Process Instruments News Standards (PINS) for complete signage specifications.

#### Assembly and Mounting Details

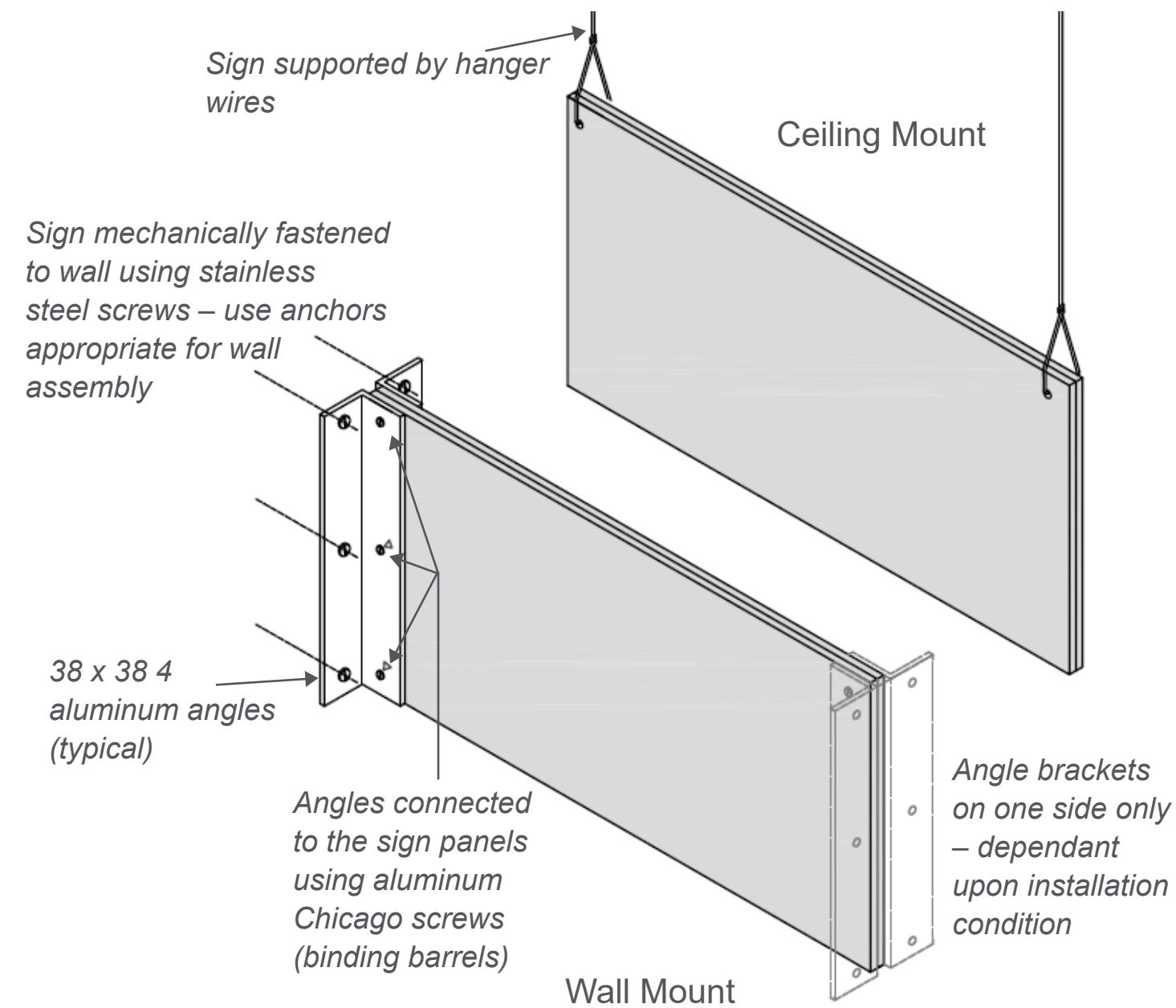

#### Overhead Sign Location Criteria

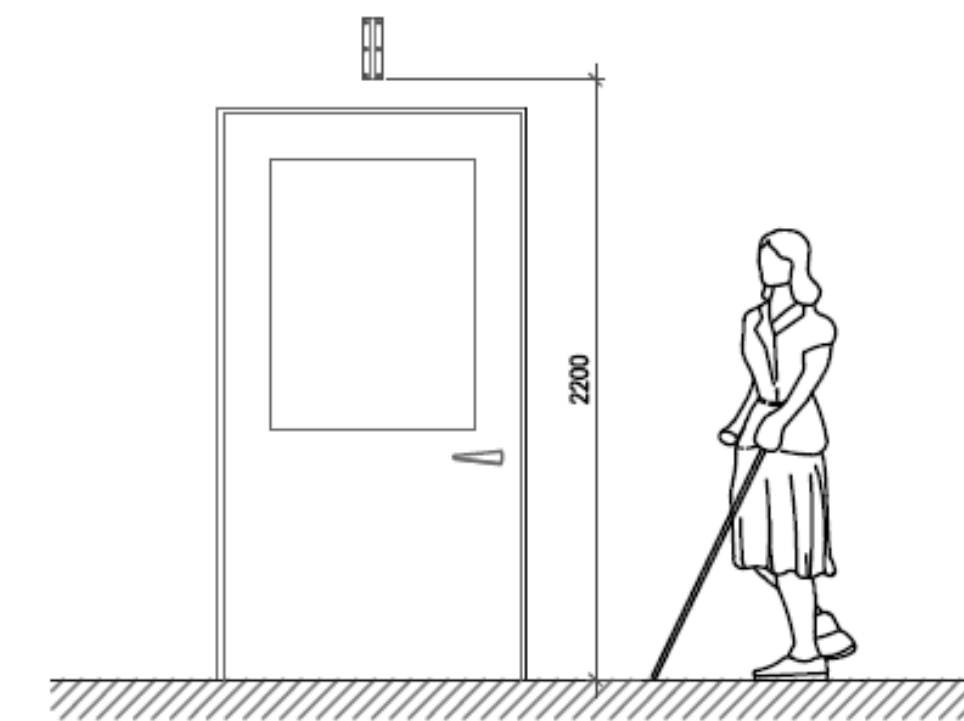

Option 1: Wall Mounted  
Sign to be mounted perpendicular to wall, centred on door

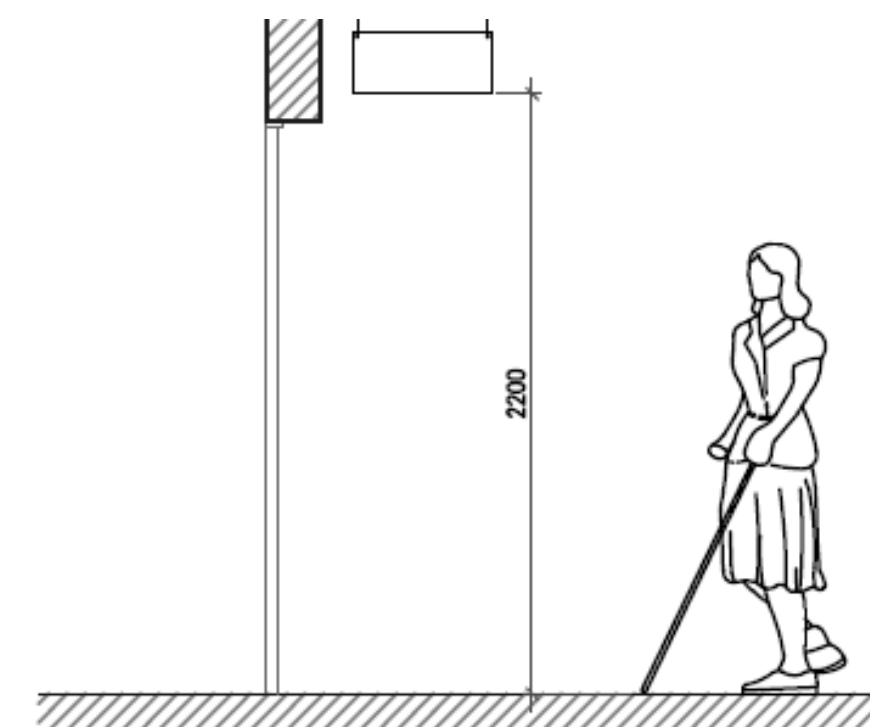

Option 2: Ceiling Mounted  
Sign to be hung from T-bar from ceiling



### 4.10.5 All Gender Washroom Signage

Wall Mounted Identification Signage Specification



Uncontracted English braille stating "all gender washroom", left aligned with text above

Uncontracted French braille stating "toilettes neutres", left aligned with text above

**Notes:**

1. Typical pictogram height is 95 mm
2. All text content and pictogram to be non-tactile
3. All dimensions are in millimeters
4. Sign background to be light grey. Pantone ID: Cool Gray 1U
5. Pictograms and text to be black. Pantone ID: Black 6U
6. Sign surface to be matte finish
7. Sign to be 6 mm THICK ACRYLIC

Symbol for Proportional Reference

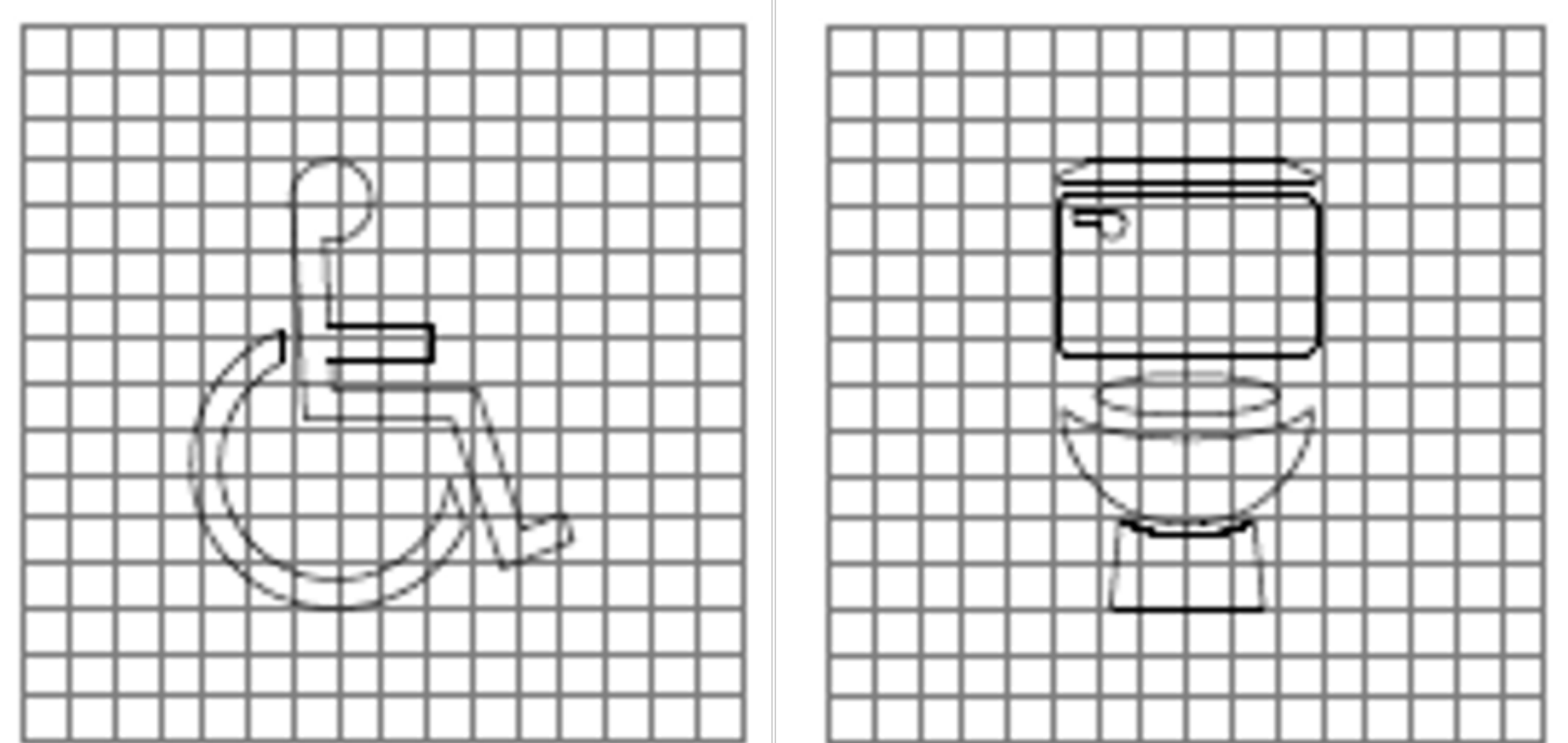

Please reference the Process Instruments News Standards (PINS) for complete signage specifications

#### 4.10.6 Common Shared Wellness/First Aid Room

##### General Information

###### Recommended Size:

Size varies according to building and project

###### Occupancy:

1-3-person

###### Accessibility Requirements:

- » AODA / OBC compliant
- » A wheelchair, by regulation, is not required however, it may be useful to have one for situations where it is difficult for an employee to reach the first aid room due to injury or illness

###### Architectural Requirements:

Entry door to have a power door operator and be lockable and accessible by an access card, to be determined by project

###### Location:

Near washrooms and centrally located and accessible to all people within the building

A dedicated space intended to promote relaxation, stress reduction, and self-care to support the physical and mental well-being of all OPS employees. As per the *Revised Regulations of Ontario (RRO) Reg1101: (First Aid Requirements)* a dedicated wellness/first aid room is required in buildings/complexes with 200 or more employees. The *Guideline on First Aid requirements in the OPS, October 2015* should also be referenced for required first aid kits and supplies (based on estimated maximum occupancy).

##### Infrastructure

- » Phone or safety/security alarm (visual and audible), dependent on emergency management protocol in the building
- » Dimmable lighting is not required by regulation; however, it may be useful to have for situations where people are light sensitive

##### Furniture Requirements

- » All required furnishings and equipment of a First Aid Room will be provided as per RRO. Reg. 1101 (First Aid Requirements)
- » Grab/rail bars are not required by regulation; however, it may be useful to have them for situations where people require assistance in transferring to the bed

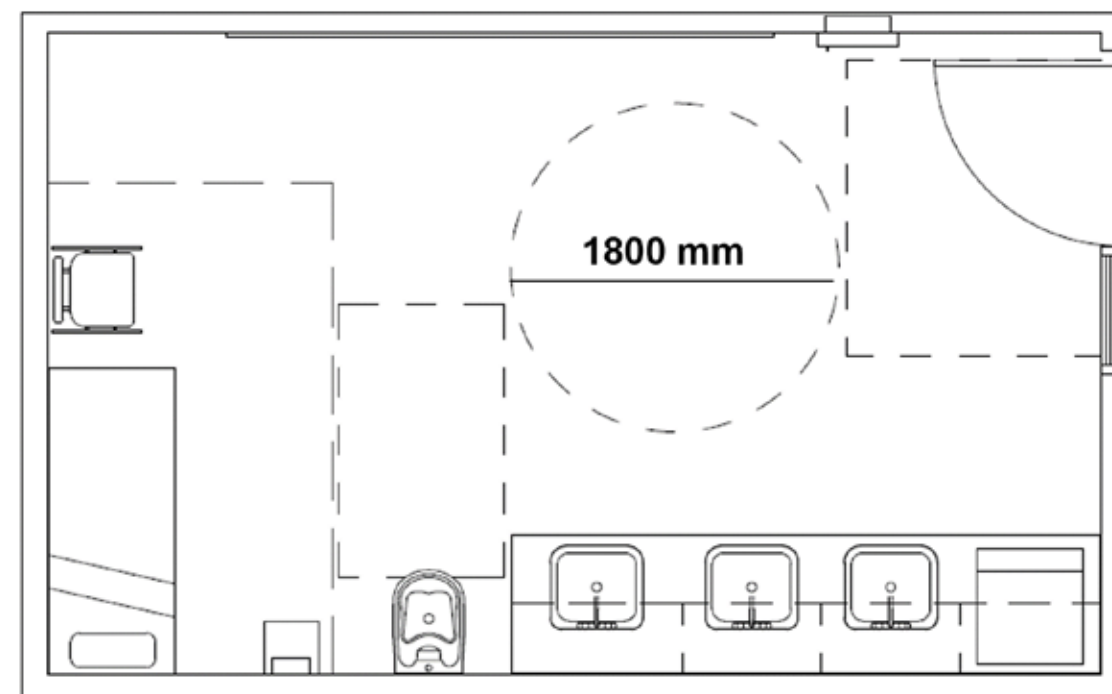

Sample Standard Plan View of Common Shared Wellness/First Aid Room

Note: Room layout is for illustrations purposes only. Size, location and architectural details will vary from project to project.



Sample Isometric view of Common Single-User Quiet Room with Ablution

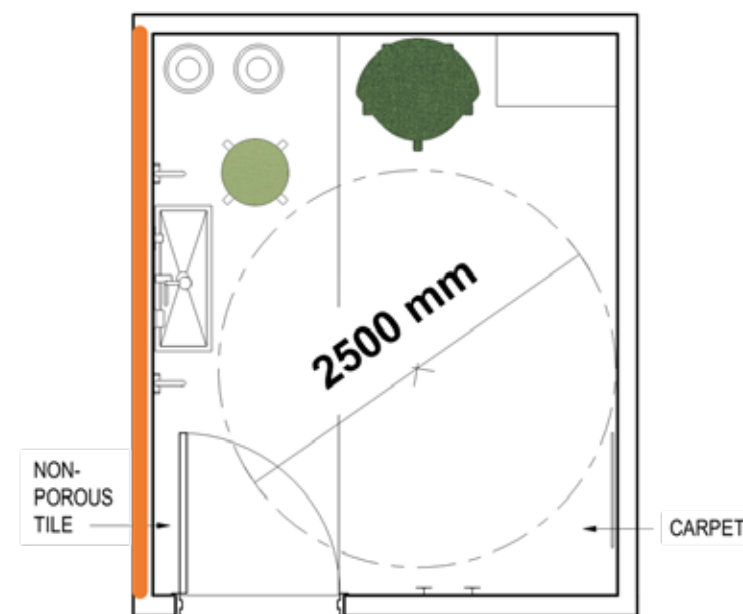

Sample Standard Plan View of Common Single-User Quiet Room with Ablution

Note: Room layouts are for illustrations purposes only. Size, location and architectural details will vary from project to project.

\*OPS Guidelines for Accessible Quiet Room, on InsideOPS  
Resources: [QiblaFinder](#) and [QiblaFinder Support](#)

— Wall to receive ceramic wall tile

#### 4.10.7 Common Shared Single-User Quiet Room with Ablution Station

##### General Information

##### Recommended Size:

Maximum 10'-0" x 12'-0" (120 USF)

Size varies according to site and project

##### Occupancy:

1-person; varies according to size and orientation of room

##### Accessibility Requirements:

- » AODA / OBC compliant
- » Provide a clear 2500 mm turning circle

##### Architectural Requirements:

- » A square or rectangular room that is entered from the south-west. This maximizes the space available for Muslim prayer, which is performed facing the north-east\*
- » Acoustic properties to reduce the noise transmission from outside of the room and from within
- » Ablution area to receive Greenboard drywall, and ceramic wall and floor tiles
- » Floor surfaces shall be slip-resistant, resilient, durable material; typically carpet but can also be resilient flooring
- » Lighting controls (dimnable) and occupancy sensors (where possible)
- » Signage on walls showing orientation/direction

##### Ambience:

- » Quiet, neutral colours, soft lighting, and simple

An inclusive and comfortable space for all OPS employees to use in a quiet manner for reflection, contemplation, meditation or personal prayer during the workday.\*

abstract designs to set mood that supports meditation, reflection and prayer\*

- » Avoid images showing people or animals, patterns are acceptable

##### Location:

- » A central, quiet location that all users can enter with their regular access cards, for easy access and users' safety\*
- » If possible, direct access to natural light, without compromising privacy
- » Near washrooms as washing before prayers is required by some religions\* (ensuring physical separation from washrooms)
- » Avoid washrooms in the direction of Qibla (north-east)

##### Infrastructure

Phone or safety/security alarm (visual and audible) for summoning emergency help\*, dependent on building's emergency management protocols

##### Ablution Station Area:

- » Water basin for ablution
- » Hand-held manual faucet with hose, not automatic
- » Low-flow fixtures (3 litres per minute or less)
- » Paper towel dispenser, soap dispenser
- » Fold-down grab bars

##### Furniture Requirements

- » 1x Waste and recycling
- » 1x Closed storage cabinet to house mats, books and literature
- » 1x Tackboard (10'-0" x 4'-0"), optional
- » 1x Mirror, not to be in the direction of prayer, optional
- » 1x Lounge chair on castors
- » 1x Stool (stackable)

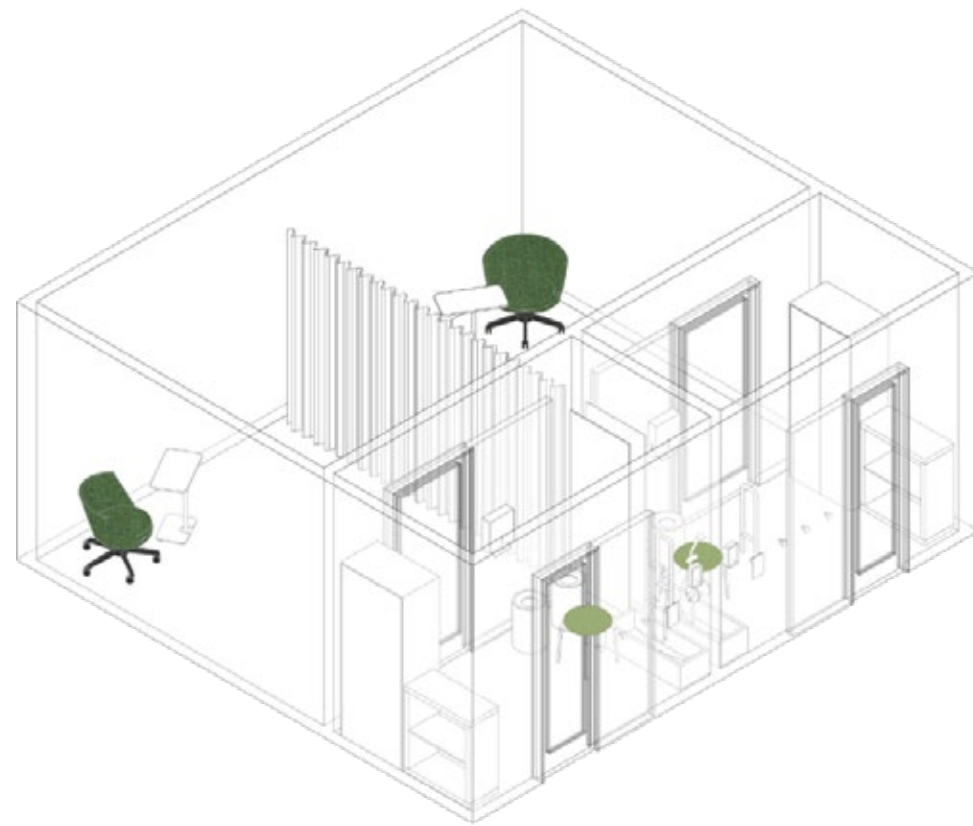

Sample Isometric view of Common Multi-User Quiet Room with ablution station

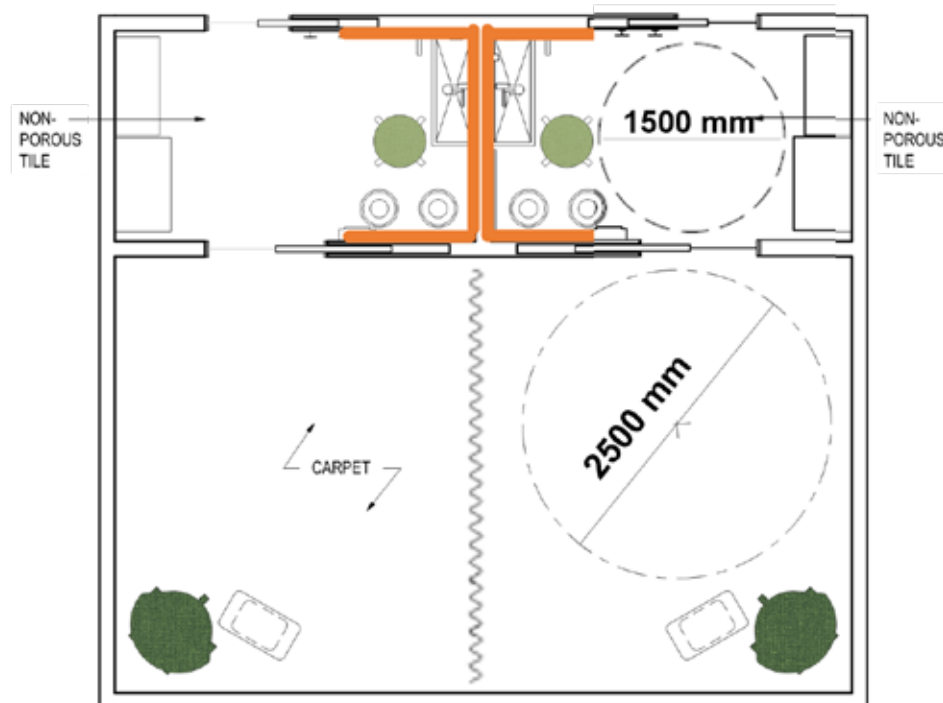

Sample Standard Plan View of Common Multi-User Quiet Room with ablution station

Note: Room layouts are for illustrations purposes only. Size, location and architectural details will vary from project to project.

\*OPS Guidelines for Accessible Quiet Room, on InsideOPS Resources: [QiblaFinder](#) and [QiblaFinder Support](#)

— Wall to receive ceramic wall tile

#### 4.10.8 Common Shared Multi-User Quiet Room with Ablution Stations

##### General Information

##### Recommended Size:

18'-0" x 20'-0" (345 USF)

Size varies according to site and project

##### Occupancy:

2 or more people; varies according to size and orientation of room

##### Accessibility Requirements:

- » AODA / OBC compliant
- » Provide a clear 2500 mm turning circle

##### Architectural Requirements:

- » A square or rectangular room that is entered from the south-west. This maximizes the space available for Muslim prayer, which is performed facing the north-east\*
- » Acoustic properties to reduce the noise transmission from outside of the room and from within
- » Ablution area to receive Greenboard drywall, and ceramic wall and floor tiles
- » Floor surfaces shall be slip-resistant, resilient, durable material; typically carpet but can also be resilient flooring
- » Lighting controls (dimnable) and occupancy sensors (where possible)
- » Signage on walls showing orientation/direction
- » Ceiling mounted curtain track with opaque room dimming, fire-resistant commercial grade curtains to run full length of ceiling height

An inclusive and comfortable space for all OPS employees to use in a quiet manner for reflection, contemplation, meditation or personal prayer during the workday.\*

- » Pocket door shall have clear width of 860mm when in open position

##### Ambience:

- » Quiet, neutral colours, soft lighting, and simple abstract designs to set mood that supports meditation, reflection and prayer\*
- » Avoid images showing people or animals, patterns are acceptable

##### Location:

- » A central, quiet location that all users can enter with their regular access cards, for easy access and users' safety\*
- » Near washrooms as washing before prayers is required by some religions\* (ensuring physical separation from washrooms)
- » Avoid washrooms in the direction of Qibla (north-east)
- » If possible, direct access to natural light

##### Infrastructure

- » Phone or safety/security alarm (visual and audible) for summoning emergency help\*, dependent on building's emergency management protocols

##### Ablution Station Area:

- » Water basin for ablution
- » Hand-held manual faucet with hose, not automatic
- » Low-flow fixtures (3 litres per minute or less)
- » Paper towel dispenser, soap dispenser

##### Furniture Requirements

- » 2x Closed storage cabinets to house mats, books and literature
- » 2x Shoe racks
- » 2x Tackboard (10'-0" x 4'-0"), optional
- » 2x Waste and recycling bins
- » 2x Mirror, not to be in the direction of prayer
- » 2x Lounge chairs on castors
- » 2x Small side table (foldable)
- » 2x Stools (stackable)
- » Privacy screen or curtain. If automatic (optional) add power controls

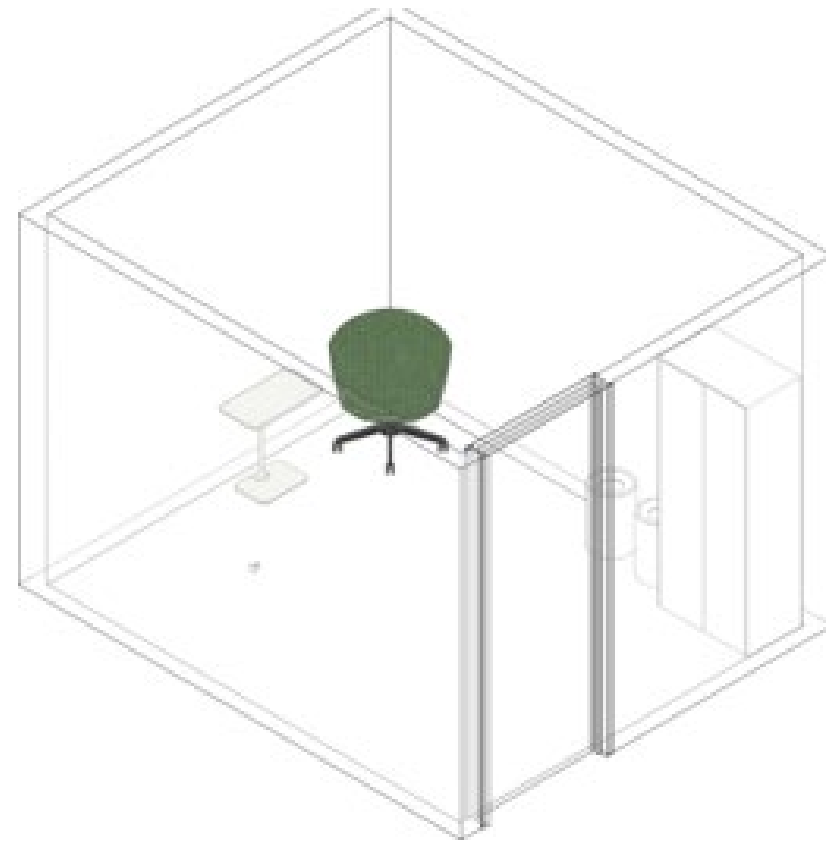

Sample Isometric view of Common Single-User Quiet Room

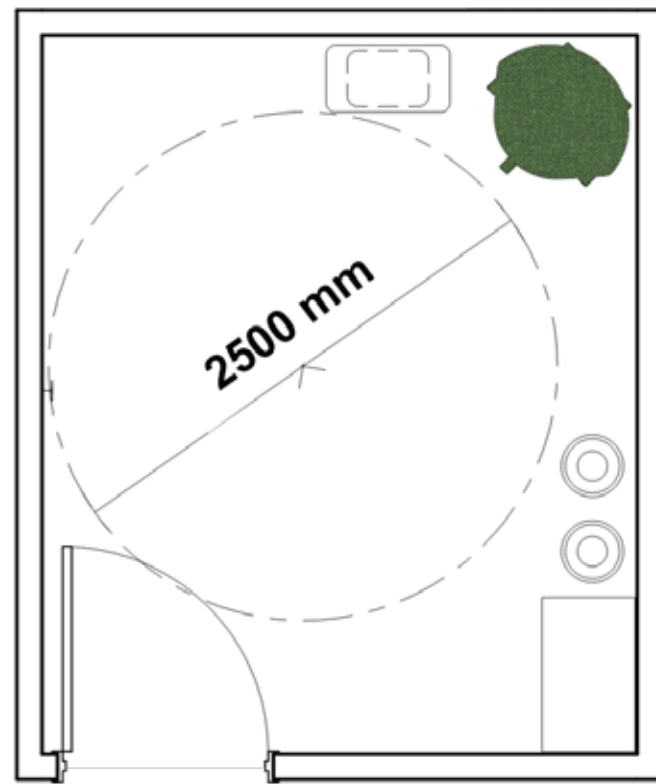

Sample Standard Plan View of Common Single-User Quiet Room

Note: Room layouts are for illustrations purposes only. Size, location and architectural details will vary from project to project.

\*OPS Guidelines for Accessible Quiet Room, on InsideOPS  
Resources: [QiblaFinder](#) and [QiblaFinder Support](#)

#### 4.10.9 Common Shared Single-User Quiet Room

##### General Information

##### Recommended Size:

Maximum 10'-0" x 12'-0" (120 USF)

Size varies according to site and project

##### Occupancy:

1-person; varies according to size and orientation of room

##### Accessibility Requirements:

- » AODA / OBC compliant
- » Provide a clear 2500 mm turning circle

##### Architectural Requirements:

- » A square or rectangular room that is entered from the south-west. This maximizes the space available for Muslim prayer, which is performed facing the north-east \*
- » Acoustic properties to reduce the noise transmission from outside of the room and from within
- » Floor surfaces typically carpet but can also be resilient flooring
- » Lighting controls (dimnable) and occupancy sensors (where possible)
- » Signage on walls showing orientation/direction

An inclusive and comfortable space for all OPS employees to use in a quiet manner for reflection, contemplation, meditation or personal prayer during the workday.\*

##### Ambience:

- » Quiet, neutral colours, soft lighting, and simple abstract designs to set mood that supports meditation, reflection and prayer \*
- » Avoid images showing people or animals, patterns are acceptable

##### Location:

- » A central, quiet location that all users can enter with their regular access cards, for easy access and users' safety\*
- » If possible, direct access to natural light, without compromising privacy
- » Near washrooms as washing before prayers is required by some religions\* (ensuring physical separation from washrooms)
- » Avoid washrooms in the direction of Qibla (north-east)

##### Infrastructure

Phone or safety/security alarm (visual and audible) for summoning emergency help\*, dependent on building's emergency management protocols

##### Furniture Requirements

- » 1x Waste and recycling
- » 1x Closed cabinets to house shoes, mats, books and literature
- » 1x Tackboard (10'-0" x 4'-0"), optional
- » 1x Lounge chair on castors
- » 1x Small side table (foldable)

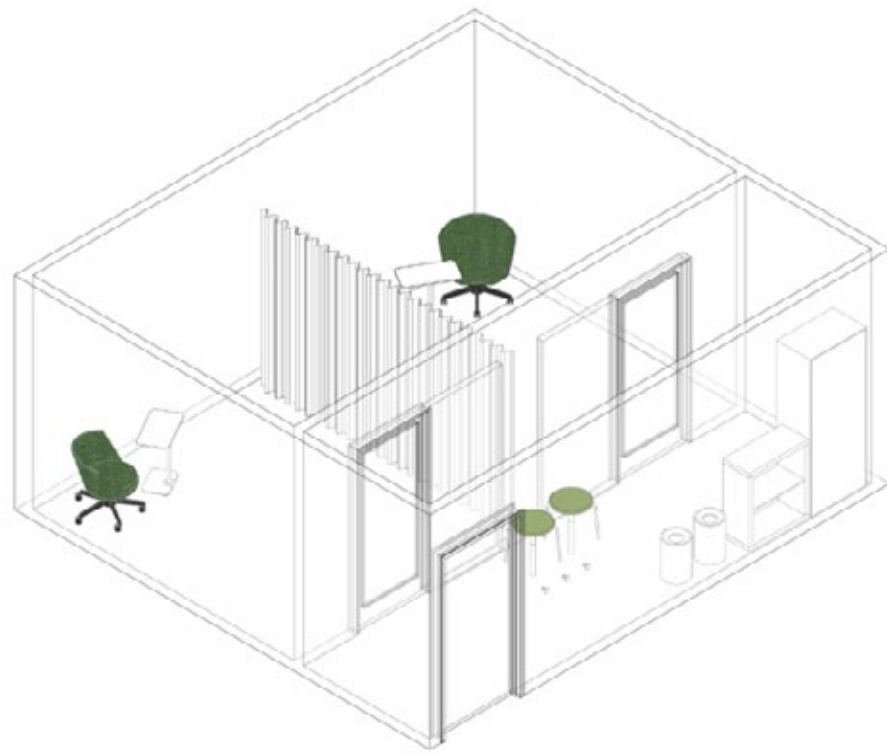

Isometric view of Common Multi-User Quiet Room

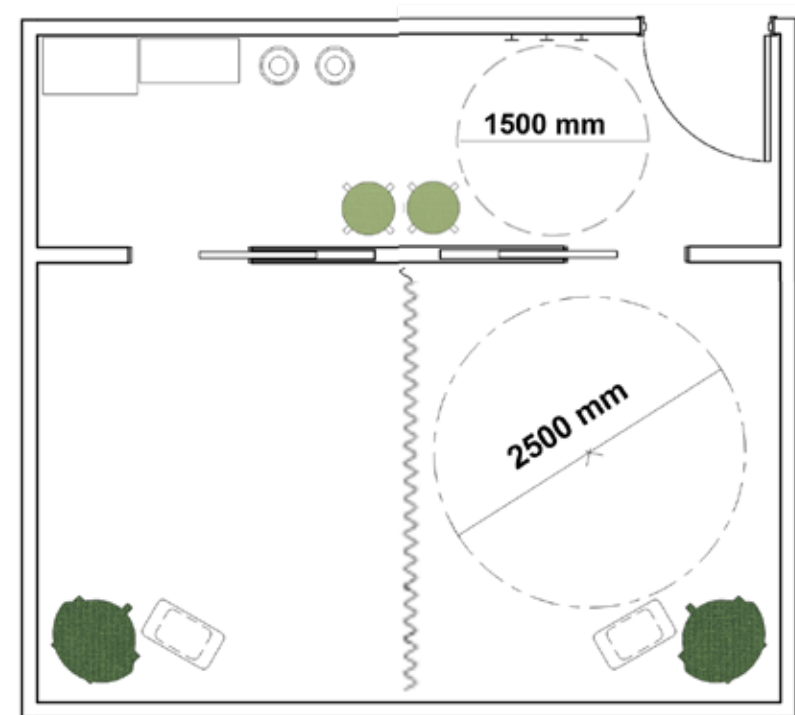

Sample Standard Plan View of Common Multi-User Quiet Room

Note: Room layouts are for illustrations purposes only. Size, location and architectural details will vary from project to project.

\*OPS Guidelines for Accessible Quiet Room, on InsideOPS  
Resources: [QiblaFinder](#) and [QiblaFinder Support](#)

#### 4.10.10 Common Shared Multi-User Quiet Room

##### General Information

##### Recommended Size:

Maximum 18'-0" x 20'-0" (345 USF)

Size varies according to site and project

##### Occupancy:

2 or more people; varies according to size and orientation of room

##### Accessibility Requirements:

- » AODA / OBC compliant
- » Provide a clear 2500 mm turning circle

##### Architectural Requirements:

- » A square or rectangular room that is entered from the south-west. This maximizes the space available for Muslim prayer, which is performed facing the north-east \*
- » Acoustic properties to reduce the noise transmission from outside of the room and from within
- » Floor surfaces typically carpet but can also be resilient flooring
- » Lighting controls (dimmable) and occupancy sensors (where possible)
- » Signage on walls showing orientation/direction
- » Ceiling mounted curtain track with opaque room dimming, fire-resistant commercial grade curtains to run full length of ceiling height
- » Pocket door shall have clear width of 860mm when in open position

An inclusive and comfortable space for all OPS employees to use in a quiet manner for reflection, contemplation, meditation or personal prayer during the workday.\*

##### Ambience:

- » Quiet, neutral colours, soft lighting, and simple abstract designs to set mood that supports meditation, reflection and prayer \*
- » Avoid images showing people or animals, patterns are acceptable

##### Location:

- » A central, quiet location that all users can enter with their regular access cards, for easy access and users' safety \*
- » If possible, direct access to natural light, without compromising privacy
- » Near washrooms as washing before prayers is required by some religions\* (ensuring physical separation from washrooms)
- » Avoid washrooms in the direction of Qibla (north-east)

##### Infrastructure

Phone or safety/security alarm (visual and audible) for summoning emergency help\*, dependent on building's emergency management protocols

##### Furniture Requirements

- » 1x Closed storage cabinet to house mats, books and literature
- » 1x Shoe rack
- » 1x Waste and recycling bins
- » 1x Tackboard (10'-0" x 4'-0"), optional
- » 2x Lounge chairs on castors
- » 1x Small side tables (foldable)
- » Privacy screen or curtain. If automatic (optional) add power controls

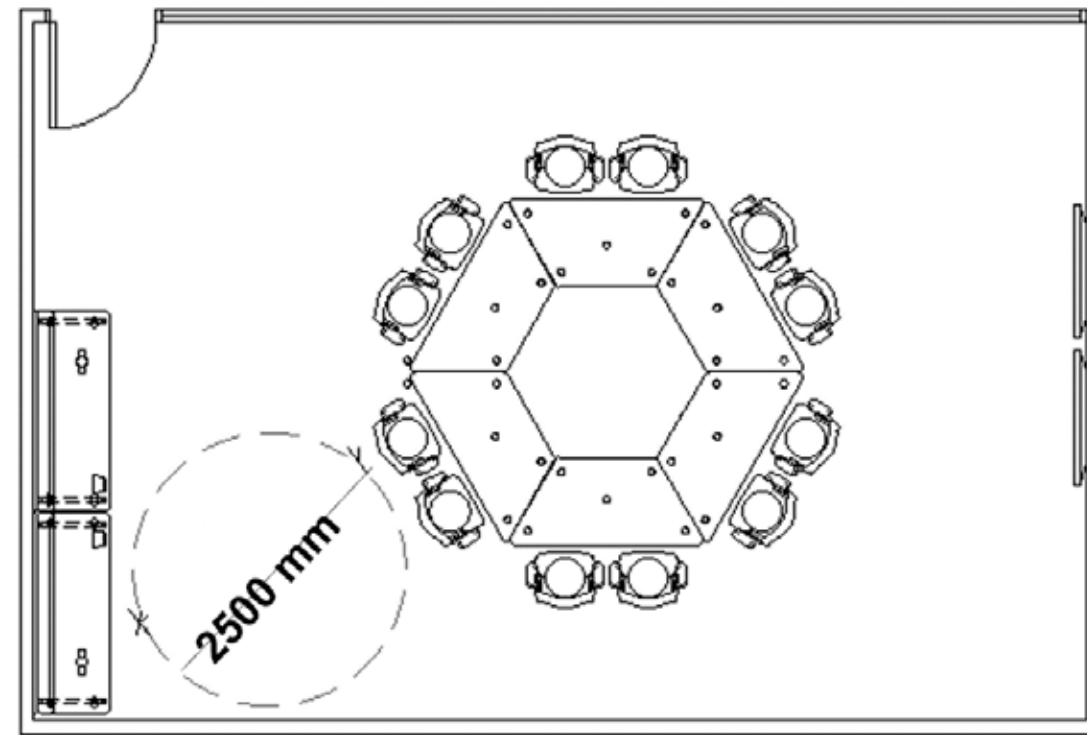
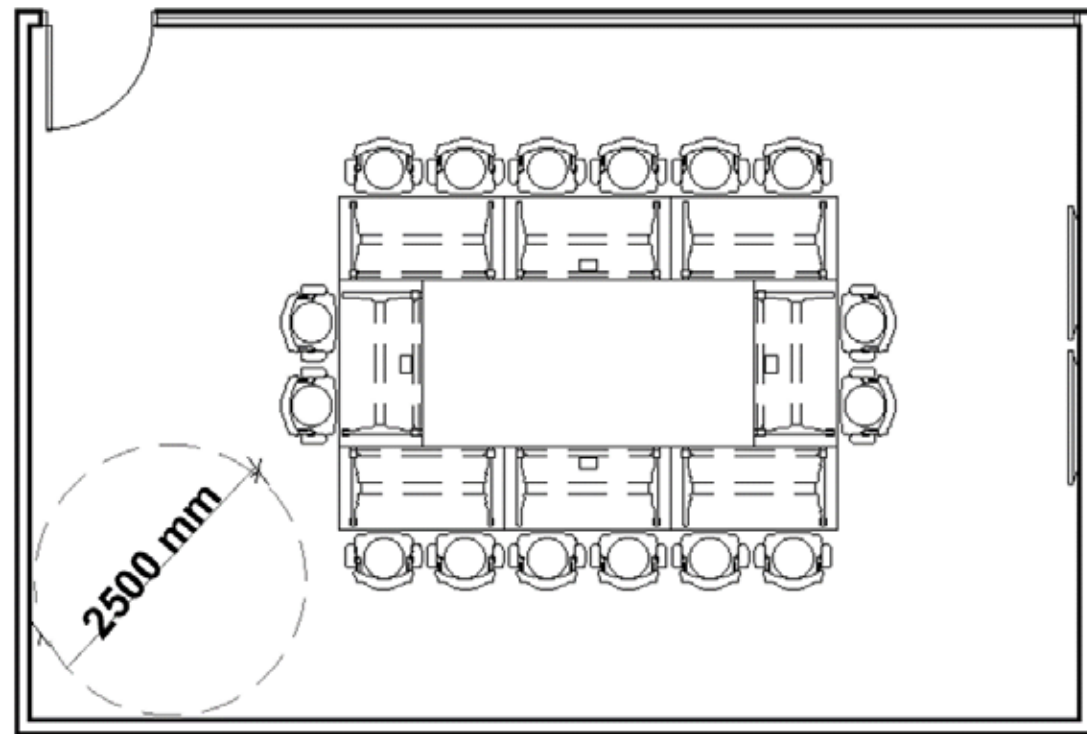

Sample Standard Plan View of Common Shared Ceremonial Room

Note: Room layouts are for illustrations purposes only. Size, location and architectural details will vary from project to project.

#### 4.10.11 Common Shared Ceremonial Room

##### General Information

##### Recommended Size:

Size varies according to building and project

##### Occupancy:

Varies according to size of room

##### Accessibility Requirements:

AODA /OBC compliant

##### Architectural Requirements:

- » Entry door can have a power door operator and be accessible by an access card, which will be determined by project
- » Non-tripping soft carpet
- » Finishes shall have a flame spread rating commensurate with smudging ceremonies

##### Base Building Requirements:

- » Upgraded HVAC, where feasible and as required, to support smudging ceremonies
- » Heat detector(s), where feasible and as required, to support smudging ceremonies
- » Changes dependent on base building capacity to support
- » In lease buildings, prior approval and compliance with applicable laws and provisions of the Lease are required

The Ceremonial room can be used to accommodate Indigenous and other Sacred Ceremonies, as well as meetings and training sessions. Inclusion of ceremonial rooms will be determined on a project-by-project basis.

##### Location:

- » A central, quiet location that all users can enter with their regular access cards, for easy access and users' safety
- » If possible, located along the perimeter for ample access to daylight

##### Infrastructure

- » Lighting control station with dimming control and pre-set buttons
- » 2x Duplex receptacles in floor box to power table
- » Phone or safety/security alarm (visual and audible), dependant on building's emergency management protocols
- » Where feasible, access to sink to support water ceremonies, varies by building and project

##### IT/AV:

- » Prepare rough-ins to receive display
- » Potential to mount a camera and/or collaboration bar above or below the display
- » Provide option for dual displays where space allows
- » Prepare rough-ins to receive room booking panel
- » Wi-fi throughout
- » Infrastructure and furniture to enable the GOVTechON digital workplace strategy. Please reference GO-ITS 80 and applicable KOP furniture requirements for technology

##### Demountable Partition Door Frame:

Infrastructure (power/data) for future room booking hardware/system

##### Furniture Requirements

- » Storage cabinet for sacred items and medicines
- » Flip top meeting tables on lockable castors to allow for easy reconfiguration
- » Electrical grommet with cable management tray below surface
- » Meeting chairs on castors (quantity will depend on size of room)
- » Lounge benches (optional depending on layout and size of room)

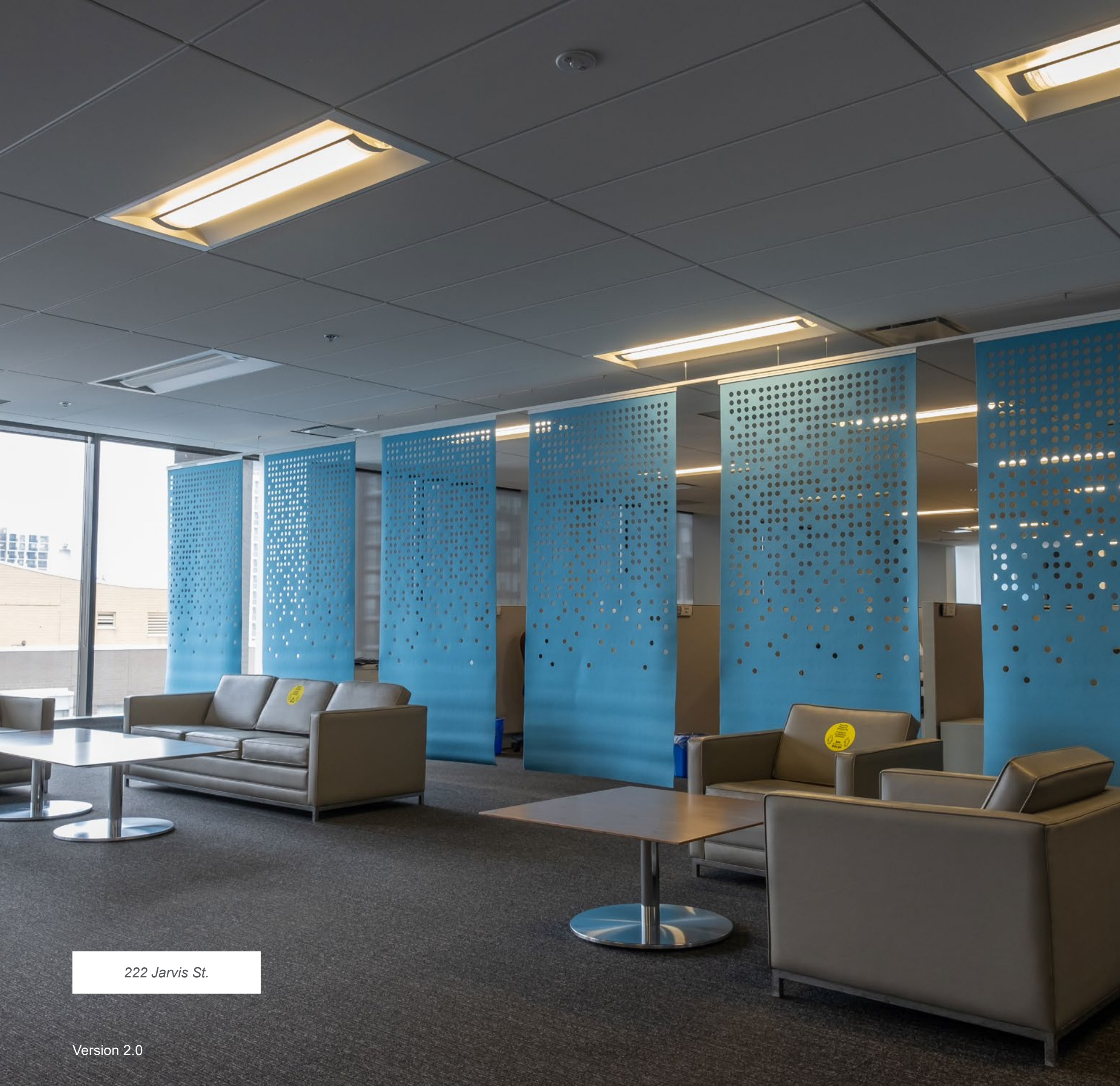

# 5.0.0 GLOSSARY

---

222 Jarvis St.



## Accessibility

Accessibility is ensuring that people of all abilities have equitable and barrier-free access to physical spaces, products, programs and services, as well as employment opportunities. The term implies conscious planning, design and/or effort to make sure something is barrier-free to persons with disabilities.

## Activity-based Working (ABW)

This is a new way of working that recognizes that employees perform a variety of activities throughout the day, such as focusing, collaborating, learning and gathering. ABW environments are characterized as having most employees in unassigned seating.

## Adjacency Principles

Refers to the practice of grouping areas or spaces that are frequently used together or have a logical connection, to promote efficiency and functionality. For example, a workspace and alternative workspace, whether enclosed or open, must have adjacency principles that address ergonomics, acoustics and lighting.

## All Gender Washroom Signage

Provides a visual to indicate a safe, welcoming and inclusive environment for all users, regardless of their gender, identity or abilities. As part of recognizing an individual's right to use the washroom that corresponds to their gender identity and/or gender expression, all gender washroom signage is required for all OPS owned and leased office accommodation space that is internal to the OPS. This includes single use universal washrooms and newly constructed/reconstructed multi-stall gendered washrooms.

## Alternative Workspaces

An open or enclosed space where employees conduct work either individually or in a group setting that is not an office or a workstation. Some alternative workspaces have the technology to support both virtual and in-person collaboration. Examples include 60-minute rooms, meeting rooms, break-out rooms, working lounges/lunchrooms, collaboration spaces, etc.

## Anthropometrics

The systematic collection and collation of measurements of the human body in order to establish averages and variations in height and shape. The use of anthropometrics in building design aims to ensure that every person is as comfortable as possible, which means that the dimensions must be

appropriate, ceilings high enough, doorways and hallways wide enough, etc.

## Barrier-Free

The building and its facilities can be approached, entered and used by persons with disabilities.

## Disability Employment Accommodation

An individualized process by which the employer prevents, removes, or mitigates barriers in the workplace to enable a person with a disability to participate equally in all aspects of recruitment and the employment lifecycle, provided that it can be done without undue hardship for the employer. Undue hardship is defined by the Ontario Human Rights Code to include cost, outside sources of funding and health and safety considerations only.

## GovTechON Digital Workplace Strategy

A strategy that equips the OPS with digital tools and service options, on modernized IT infrastructure. This enables the opportunity for a consistent experience with added flexibility in how we work in the office, while ensuring data and systems are protected.

## Guiding Principles

Key concepts that inform and drive workplace strategy for planning office reorganization, relocation and/or the transition to activity-based working.

## Inclusive Design

Considers the full range of human diversity concerning ability, language, culture, gender, age and other forms of human difference.

## Modularity

A design approach that provides an organization with the ability to accommodate changing business objectives and to quickly scale up or down while saving time and money.

## Neighbourhoods

Designated areas within the workplace that include various space types from the Kit of Parts (e.g. offices, workspaces, 60-minute rooms, breakout rooms, intersections, etc.) that are adjacent to each other and support activity-based working. Depending on the size of the space there may be multiple neighborhoods on a floor. Neighborhoods can also be designated for team

members in a Division or Branch to easily find one another.

## Ontario's Reality Directive

Applies to both government-owned facilities and space leased from third-party property owners. Within the Realty Directive, the Office Accommodation Space standard is up to 180 Rentable Square Feet (RSF) or 160 Useable Square Feet (USF) per workspace and a minimum sharing ratio of 1.3 staff persons per workspace which applies to all newly acquired and renovated office accommodations.

## Rentable Square Feet

The space used to calculate rental payments. This includes the tenant's useable area and its proportionate share of floor common area and building common area, less any major vertical penetrations.

## Sharing ratio

The number of employees per workspace.

## Support Spaces

Spaces beyond workspaces and alternative workspaces that are needed for office function, such as print/copy area, storage and filing areas/rooms, reception/welcome center, etc.

## Turning Circle

A circular space that allows an individual using a mobile device to make a 360-degree turn.

## Universal Design

Universal Design is the design and composition of an environment so that it can be accessed, understood and used to the greatest extent possible by all people regardless of their age, size, ability, or disability.

## Universal Washroom

Also known as an accessible washroom, is a washroom that can be used by anyone with any ability. These washrooms are designed to be inclusive and accommodate the needs of a diverse range of individuals, including those who require assistive devices or have mobility impairments. Universal washrooms typically include features such as but not limited to grab bars, ample floor space and accessible fixtures. The goal is to provide a safe, welcoming and inclusive

environment for all users, regardless of their gender, identity or abilities.

**Useable Square Feet**

The amount of space within a building suitable for occupancy and use, after subtracting non-usable areas such as corridors, mechanical rooms and other non-occupiable spaces.

**Work Settings**

Any space within an office environment that supports the work of employees on an individual and shared basis (i.e. includes all workspaces, alternative workspaces and support spaces within a workplace).

**Workplace**

A physical location where people go to work, an office environment located within a building.

**Workspaces**

An office or workstation that provides a base for activity-based working.

# ACKNOWLEDGEMENTS

---

The content of this document was developed by the Office Optimization Division at the Ministry of Infrastructure, in partnership with Infrastructure Ontario.

We would like to acknowledge all our partners who have provided their expertise, advice, and input into this document.

CO – Corporate Planning and Services Division

TBS – Employee Relations and Negotiations Division

SOLGEN – Office of the Provincial Security Advisor

MOI – Realty Division

Indigenous Affairs Ontario (IAO) - Indigenous Relations and Programs Division

TBS – People and Culture Division

MCM - Heritage, Tourism and Culture Division

MPBSD – Infrastructure Technology Services

MPBSD – Information, Privacy and Archives

OPS Employee Networks

# CONTACT INFORMATION

Thank you for your interest in the OMOS. Please direct any enquires or questions via the [OPS Office Space Intake Form](#).

Version	Date	Comments
Version 1.0	March 2023	» First iteration of the office design standards for OPS office spaces which will be updated in six months and then annually.
Version 2.0	December 2023	» The “About this Document” section has been updated to reflect the recent updates. » A section on common shared spaces has been added to Key Planning Considerations and the KOP, which now includes design elements for the wellness/first aid rooms, quiet rooms and ceremonial rooms. » A section on a common OPS colour strategy has been added to the Key Planning Considerations section and the iconic nature color scheme has been incorporated into the KOP. » Minor edits incorporated into the accessibility space standards section of the KOP to clarify language.

Second iteration of the office design standards for OPS offices spaces, which will be updated annually.

**Ontario** 

 **Infrastructure  
Ontario**